

# Kit 4005

SUBARU Forester, 5-dr SUV, 03-07

This kit is only for vehicles with flush or integrated side railing.



460R  
753



460



**Kit**



753



x4



x4



x4



16 mm

x8

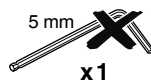

5 mm

x1



x4



x1

460R

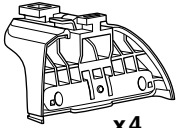

x4



x4



x4



16 mm

x8

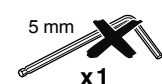

5 mm

x1



x4

460

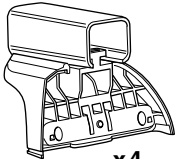

x4



x4



x4



16 mm

x8

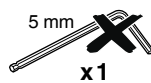

5 mm

x1



x4

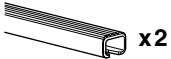

x2



x2

23 mm



x1

17 mm



x2

23 mm

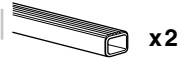

x2

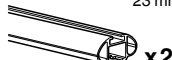

x2

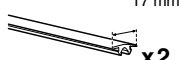

x2

23 mm

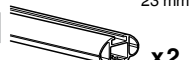

x2



x4

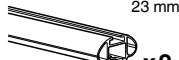

x2

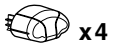

x4



x4

1

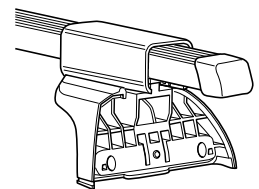
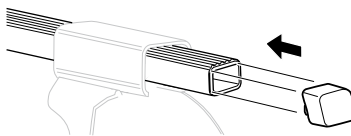
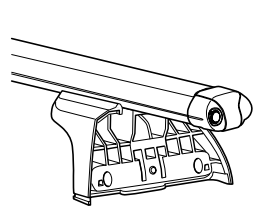
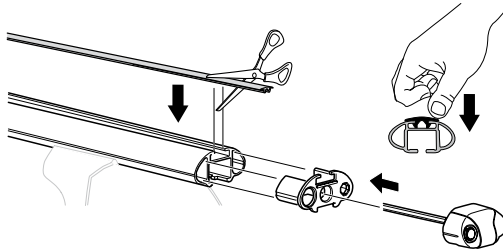
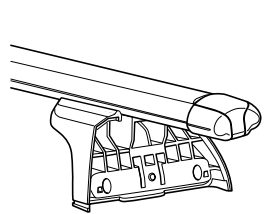
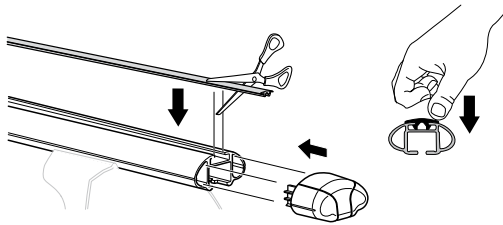
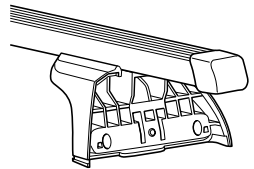
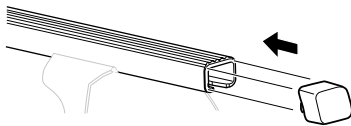
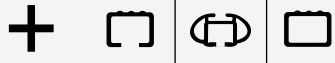

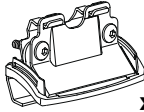
**2****x 4****i**

<b>GB</b>	Only a few turns	<b>EST</b>	Ainult mõni pööre	<b>HR</b>	Samo nekoliko okreta
<b>D</b>	Nur wenige Umdrehungen	<b>LAT</b>	Tikai dažī apgriezieni	<b>HU</b>	Csak néhány fordítás
<b>F</b>	Quelques tours uniquement	<b>LIT</b>	Tik keli pasukimai	<b>GR</b>	Μόνο μερικές στροφές
<b>NL</b>	Slechts enkele slagen	<b>PL</b>	Wystarczy kilka obrotów	<b>TR</b>	Yalnız birkaç kez çevirm
<b>I</b>	Solo qualche giro	<b>RU</b>	Достаточно нескольких оборотов	<b>中文</b>	只有几个转向
<b>E</b>	Sólo algunas vueltas	<b>CZ</b>	Pouze několik otáček	<b>한국어</b>	두 세 번만
<b>PT</b>	Noções básicas	<b>SK</b>	Len niekoľko otáčok	<b>日本語</b>	数回転のみ
<b>S</b>	Endast några varv	<b>SLO</b>	Le nekaj obratov	<b>ไทย</b>	หมุนเพียงไม่กี่รอบ
<b>FIN</b>	Vain muutama kierros				

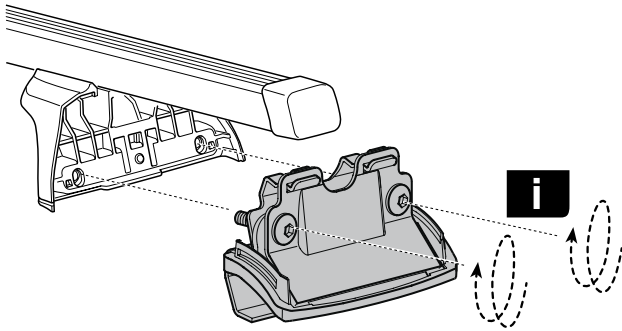
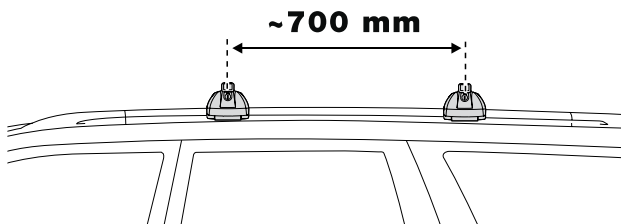
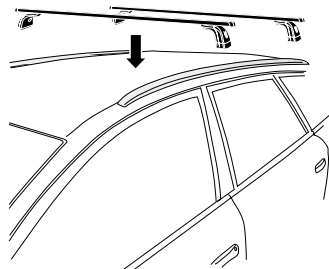
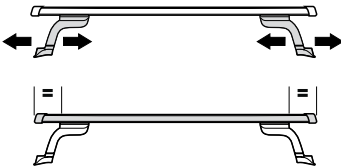
**3**

4

A

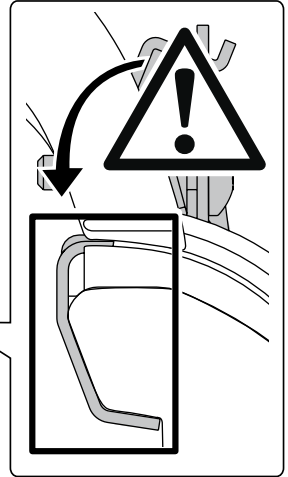
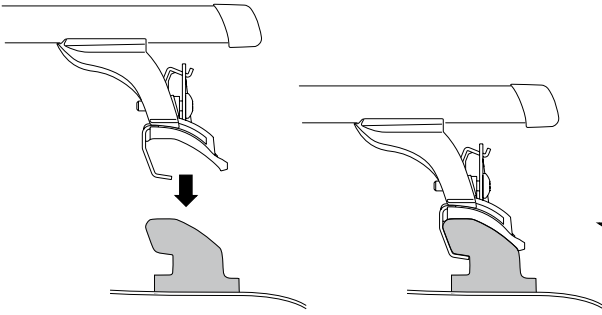

B

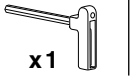

x1

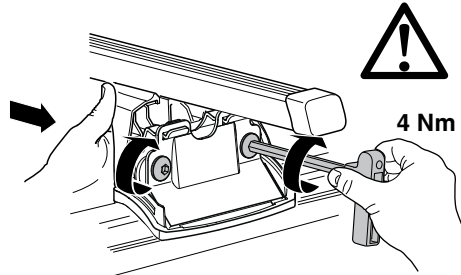
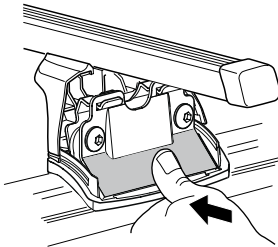

GB/US  
D  
F  
NL  
I  
E  
PT  
S  
FIN  
EST  
LAT  
LIT  
PL  
RU

Tighten alternately  
Die Schrauben abwechselnd anziehen  
Serrer alternativement chaque côté  
Afwisselend aan de linker- en de rechterkant aandraaien  
Alternare il serraggio delle viti  
Apretar alternativamente  
Aperte alternadamente  
Dra åt växelvis  
Kierrä vuorotellen  
Pinguldage vaheldumisi  
Pievelciēt pamišus  
Užsukinėkite pakaitomis  
Śruby dokręcaj naprzemiennie  
Затягивайте попеременно

CZ  
SK  
SLO  
HR  
HU  
GR  
TR  
中文  
한국어  
日本語  
ไทย

Pokrętał bagażnika dokręcaj dokręcaj naprzemiennie.  
Dotahujte striedavo  
Privijajte izmenično.  
Naizmjenično zategnite  
Egymástól függetlenül szorítandó  
Σφιγγετε εναλλάξ  
Dönüşümlü sıkın  
交替拧紧  
번갈아 가며 조이십시오.  
交互に締め付けてください。  
ขึ้นในแบบสลับ



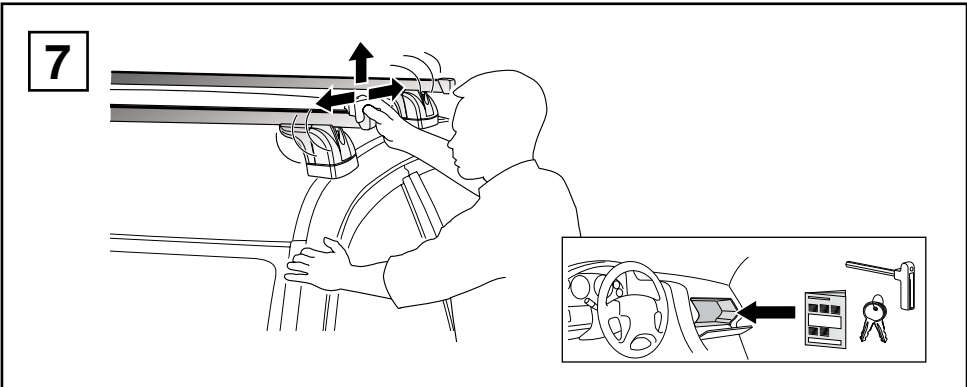
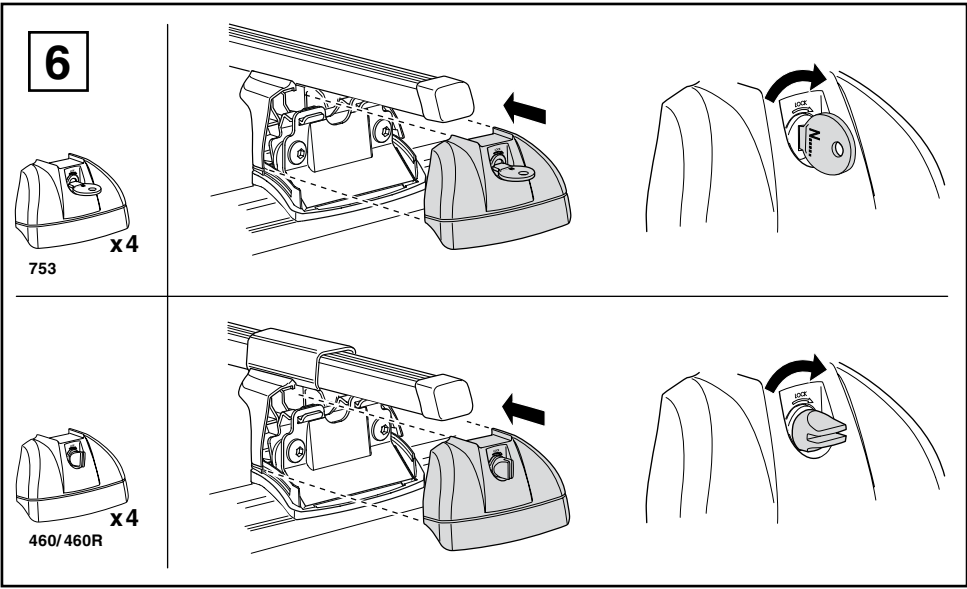
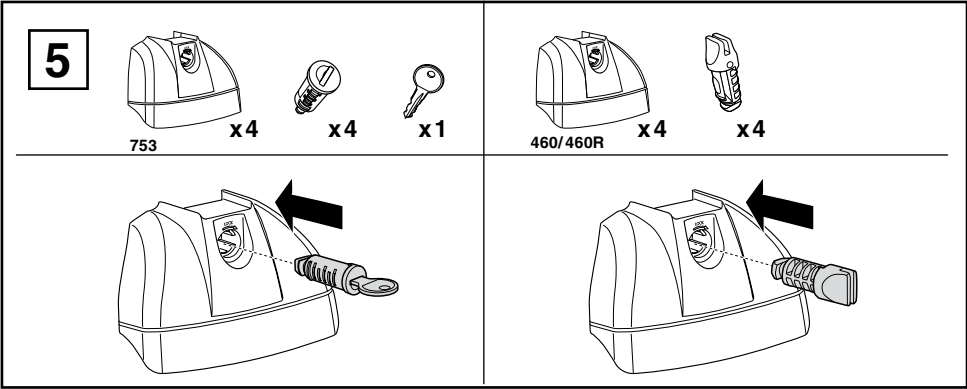

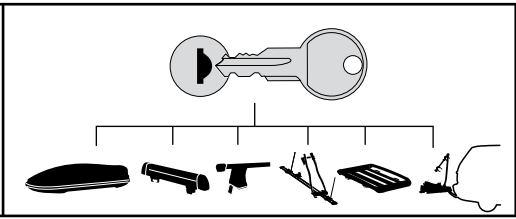
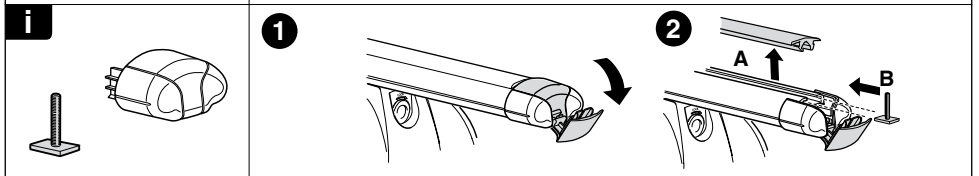
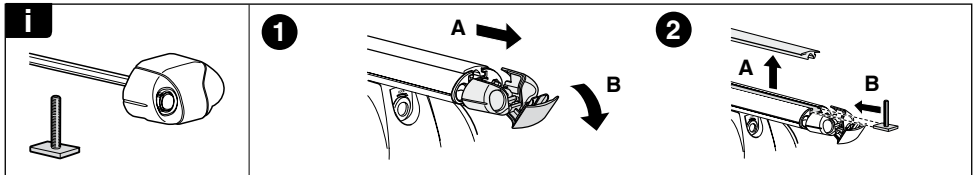
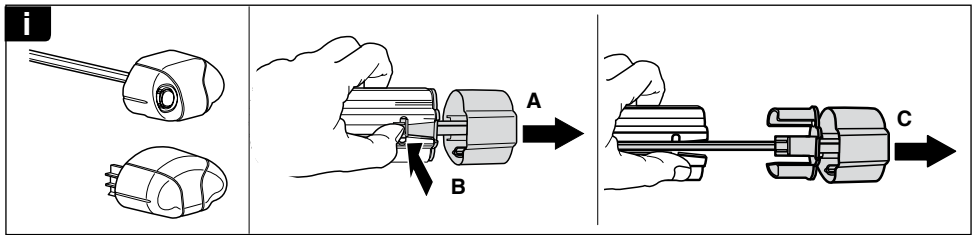
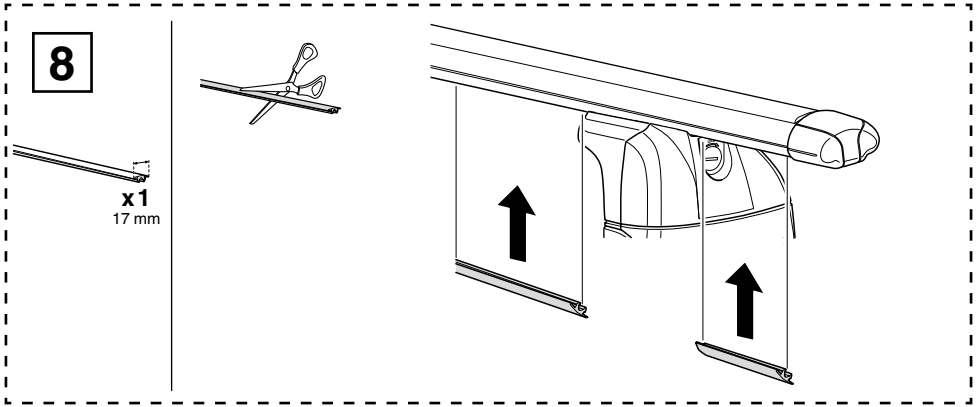

- 544 (x4)
- 596 (x6)
- 588 (x8)
- NA 510 (x10)
- EUR ASIA 452 (x12)

WW ▶ Thule Sweden AB, Box 69, 330 33 Hillerstorp, SWEDEN  
 NA ▶ Thule Inc., 42 Silvermine Road, Seymour, Connecticut 06483, USA

info@thule.com  
 customer.service@thule.com

www.thule.com