

Kit 3092

SUZUKI SX4, 5-dr Hatchback, 06-

This Kit is only for vehicles with fixpoint mounting.

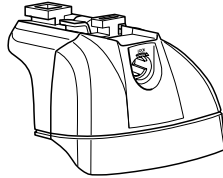

460R
753

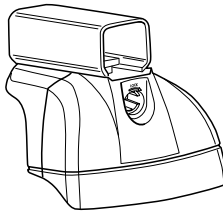

460

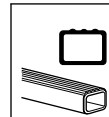

xx kg
 xx lbs + 5 kg
 11 lbs =

Max.
40 kg

Max.
88 lbs

80 km/h 130 km/h
 50 Mph 80 Mph
 40 km/h 25 Mph
km/h
Mph

+

Kit XXXX

A

B

C

17 x 4

135 x 4

x 1

51297

x 4

x 4

x 4

x 4

x 1
 3 mm

x 1

Kit

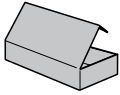

753

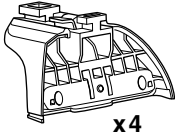

x4



x4



x4



x8

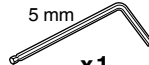

x1



x4



x1

460R

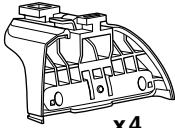

x4



x4



x4



x8

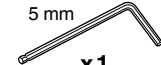

x1



x4

460

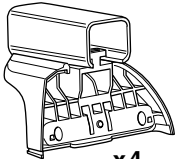

x4



x4



x4



x8

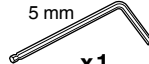

x1



x4

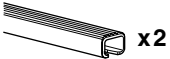
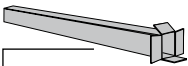

x2



x1

17 mm



x2

23 mm



x2

23 mm

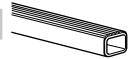

x2



x2

23 mm

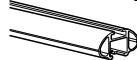

x2

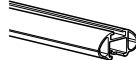

x2

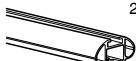

x2



x4



x4



x4

1

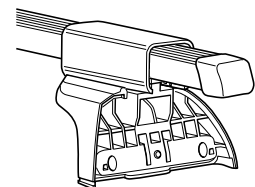
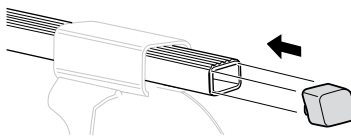
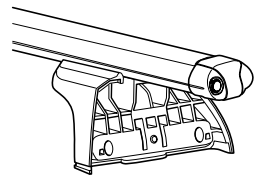
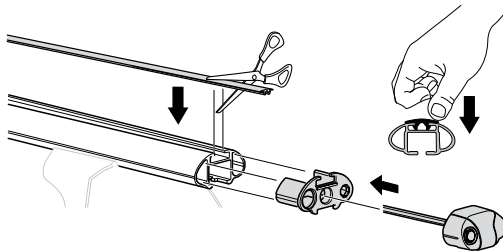
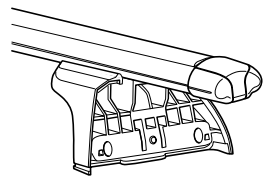
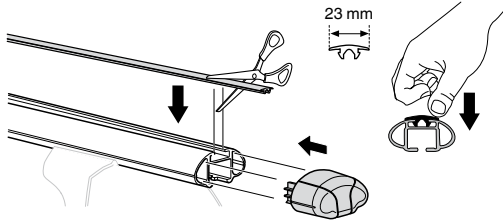
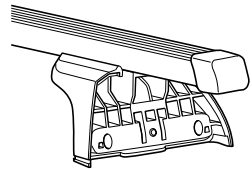
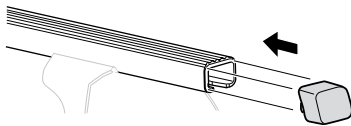
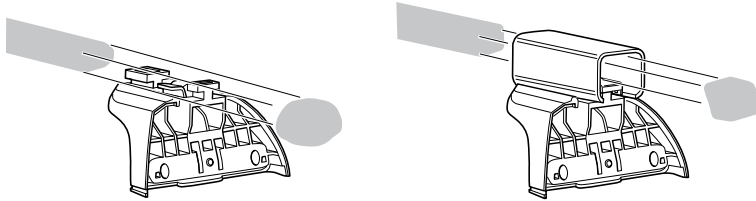
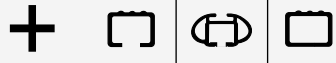
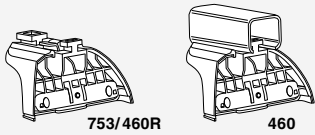

2

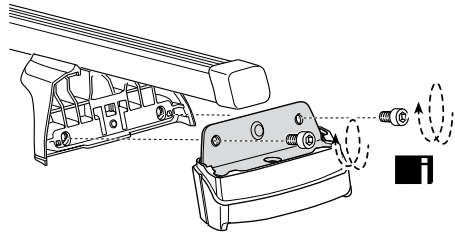
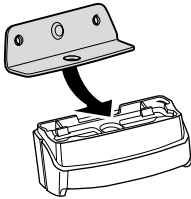
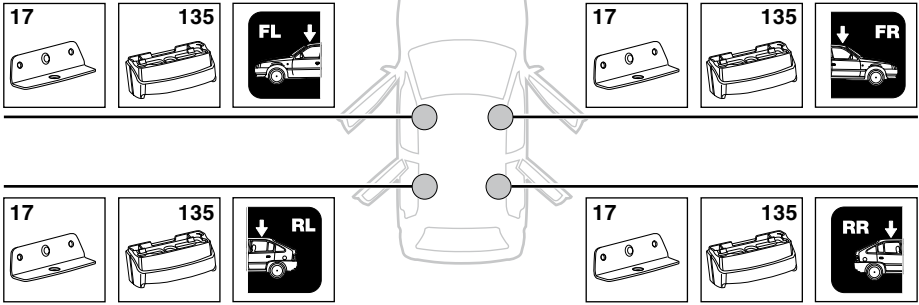
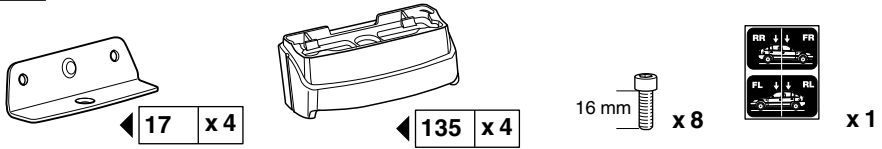

i

- | | | |
|------------------------------------|--|------------------------------------|
| GB Only a few turns | EST Ainult mõni pööre | HR Samo nekoliko okreta |
| D Nur wenige Umdrehungen | LAT Tikai dažī apgriezieni | HU Csak néhány fordítás |
| F Quelques tours uniquement | LIT Tik keli pasukimai | GR Μόνο μερικές στροφές |
| NL Slechts enkele slagen | PL Wystarczy kilka obrotów | TR Yalnız birkaç kez çevirm |
| I Solo qualche giro | RU Достаточно нескольких оборотов | 中文 只有几个转向 |
| E Sólo algunas vueltas | CZ Pouze několik otáček | 한국어 두 세번만 |
| PT Noções básicas | SK Len niekoľko otáčok | 日本語 数回転のみ |
| S Endast några varv | SLO Le nekaj obratov | ไทย หมุนเพียงไม่กี่รอบ |
| FIN Vain muutama kierros | | |

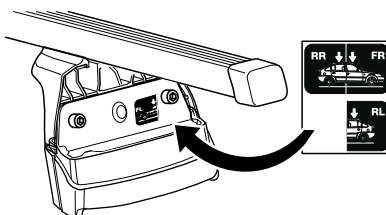

3

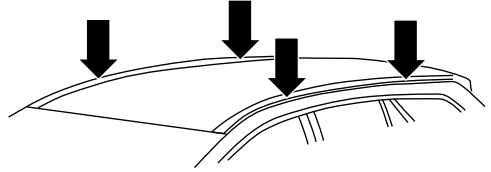
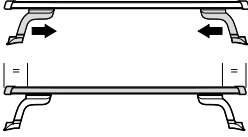
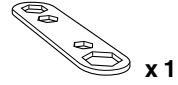
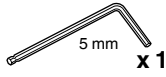
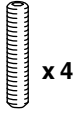
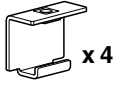

A

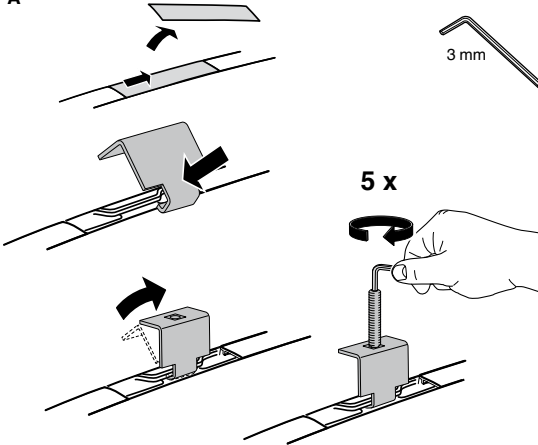

B

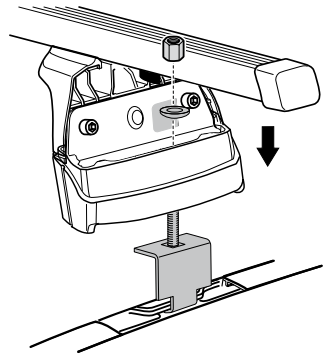

C

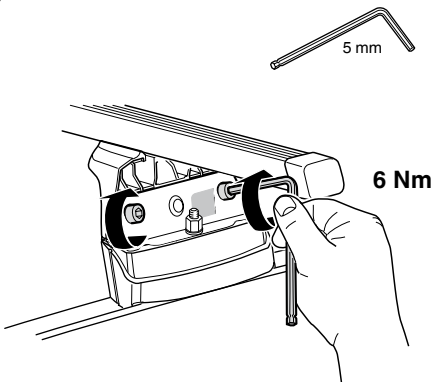

D

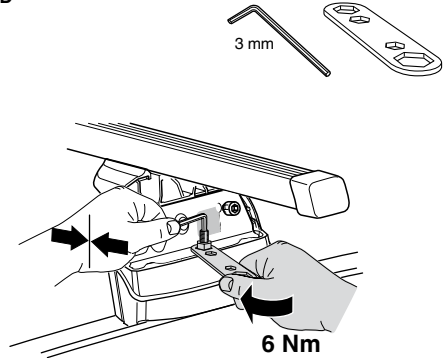

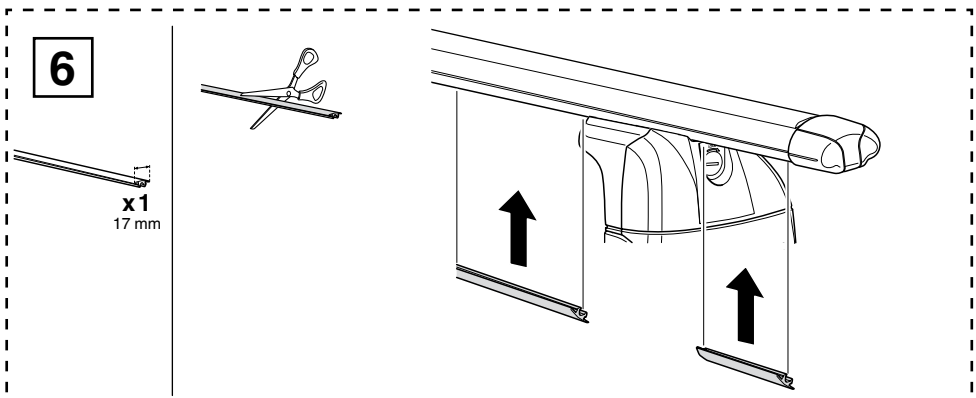
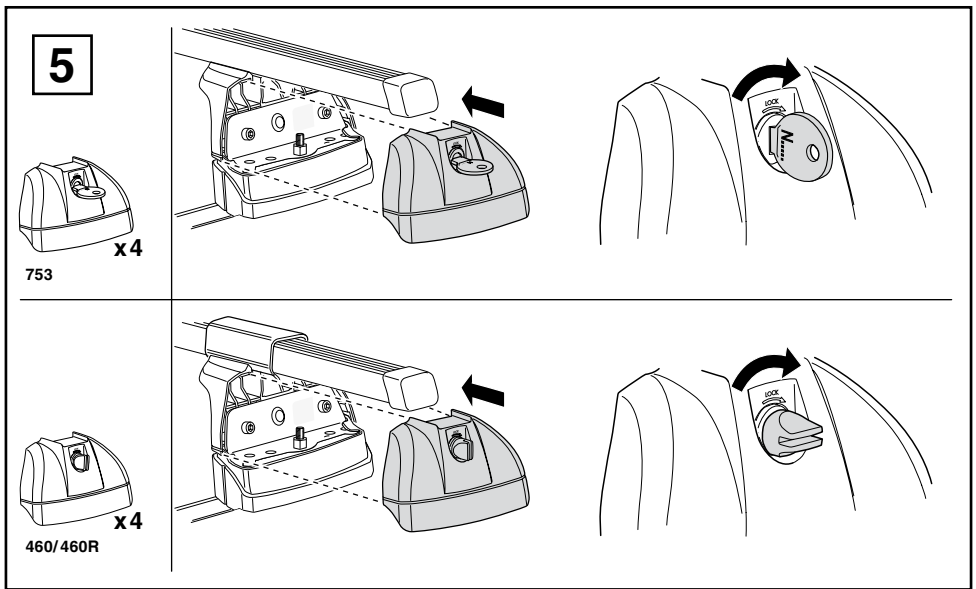
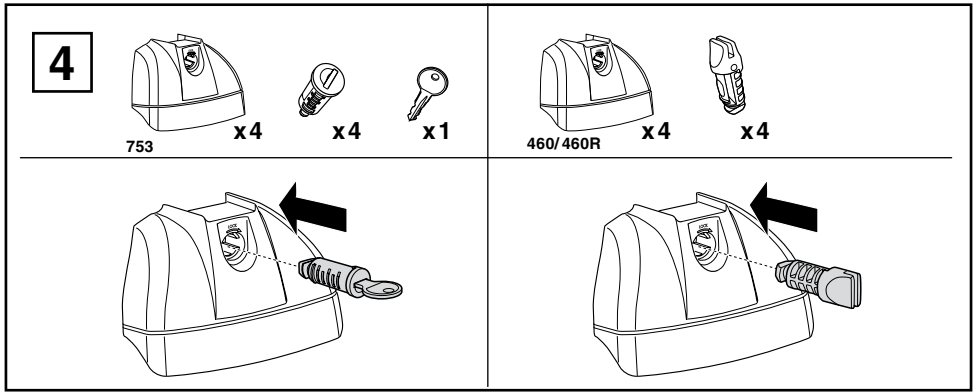

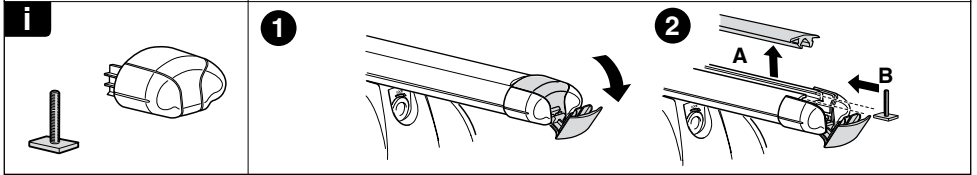
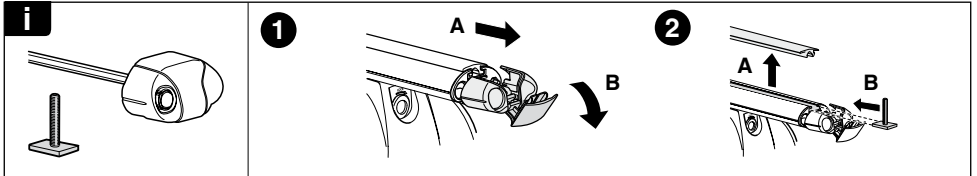
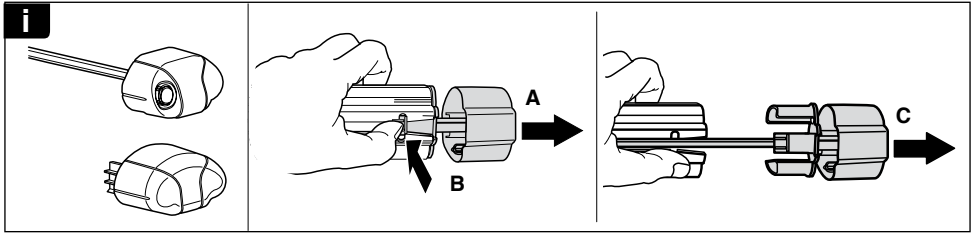



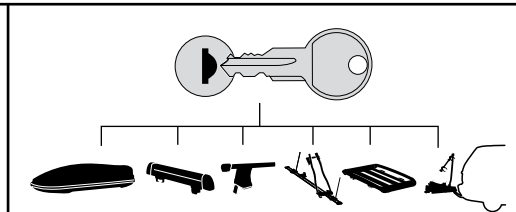



THULE
SWEDEN
**ONE
KEY
SYSTEM**



-  **544** (x4)
-  **596** (x6)
-  **588** (x8)
-  **NA 510** (x10)
-  **EUR 452** (x12)

WW ▶ Thule Sweden AB, Box 69, 330 33 Hillerstorp, SWEDEN
NA ▶ Thule Inc., 42 Silvermine Road, Seymour, Connecticut 06483, USA

 info@thule.com
customer.service@thule.com

 www.thule.com