

Kit 3084

CHRYSLER PT Cruiser, 5-dr Estate, 01-08

CITROËN Xantia, 5-dr Estate, 96-01

CITROËN Xsara, 5-dr Estate, 96-06

MERCEDES Viano, 4-dr Bus, 96-03, 04-

MERCEDES Viano Marco Polo, 4-dr Bus, 96-03, 04-

MERCEDES Vito, 4-dr Van, 96-03, 04-

This Kit is only for vehicles with T-profile.

460R
753

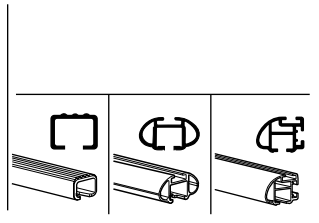
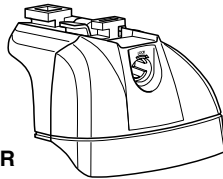

460

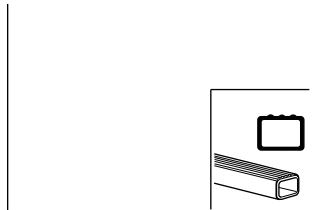
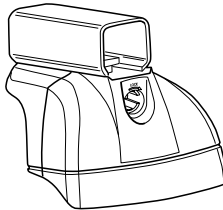

751

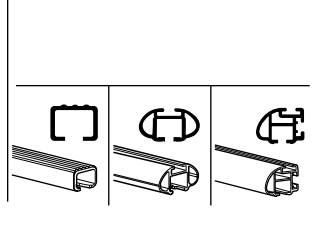
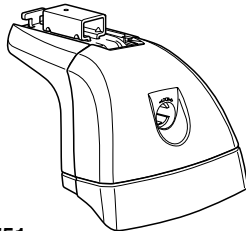

THULE[®]
SWEDEN

ISO 11154-E

6 kg / 13 lbs + xx kg xx lbs = **Max. 75 kg / 165 lbs**

9 kg / 20 lbs + xx kg xx lbs = **Max. 150 kg / 330 lbs**

12 kg / 26 lbs + xx kg xx lbs = **Max. 200 kg / 440 lbs**

Kit

52100

- x 8
- x 4
- x 8
- 3 mm x 1
- x 8
- x 1

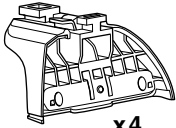
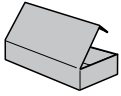

753

x4



x4



x4



16 mm
x8



5 mm
x1



x4



x1

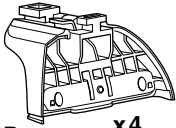

460R

x4



x4



x4



16 mm
x8



5 mm
x1



x4

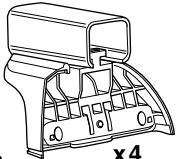

460

x4



x4



x4



16 mm
x8



5 mm
x1



x4

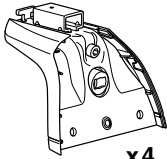

751

x4



x4



x4



12 mm
x8



5 mm
x1



x4



x1

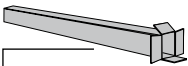

x2

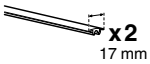

x2

17 mm

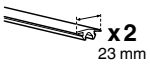

x2

23 mm

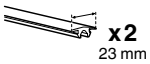

x2

23 mm

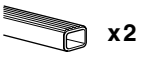

x2

23 mm

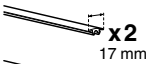

x2

17 mm

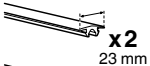

x2

23 mm

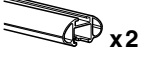

x2

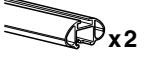

x2

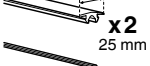

x2

25 mm

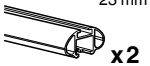

x2



x4

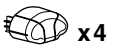

x4



x4

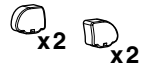

x2

x2

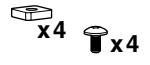

x4

x4



x1

5 mm

1

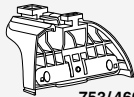

753/460R

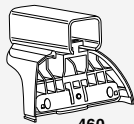

460

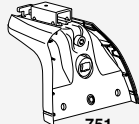

751

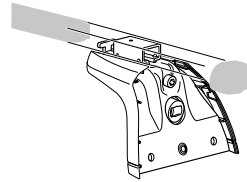
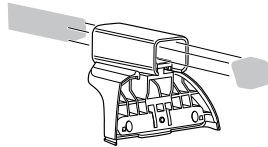
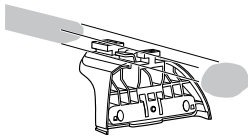

x4

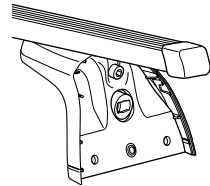
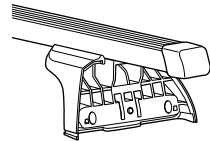
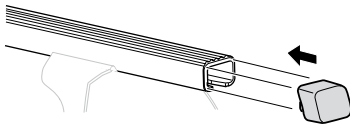

x4

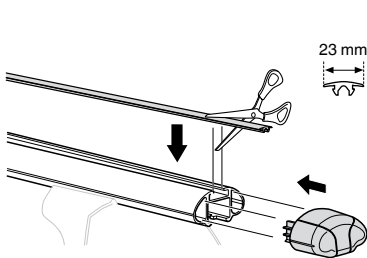

23 mm

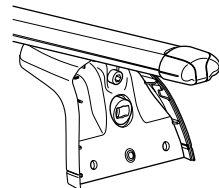
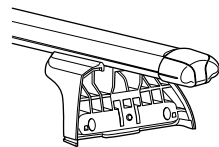
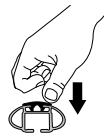



x4

x4

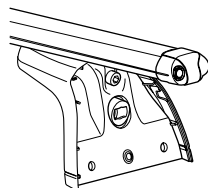
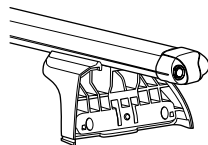
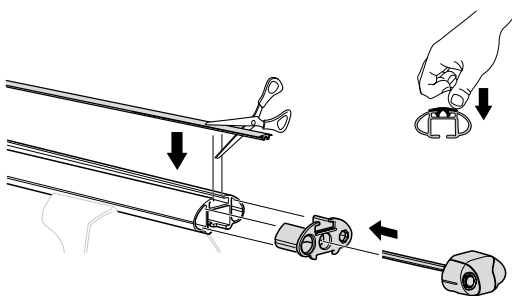

x4

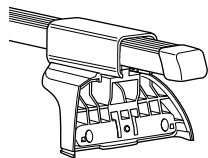
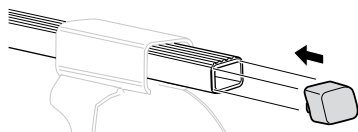

x2

x2

x4

x4

x1
5 mm

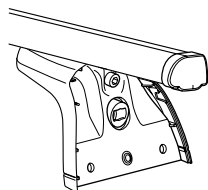
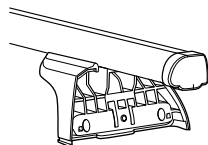
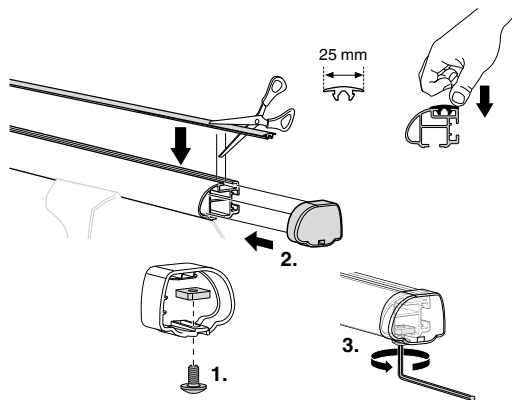

2

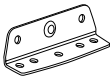

04 x 4



43 x 4

16 mm x 8



x 1

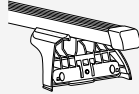

753/460R

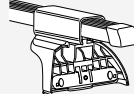

460

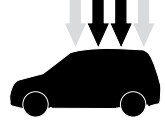

04

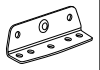

43



04

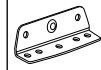

43

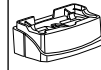

04

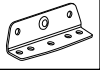

43



04

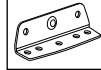

43

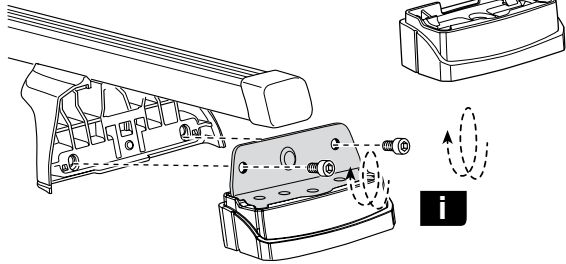
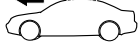
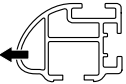
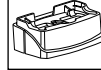

i

i

- GB** Only a few turns
D Nur wenige Umdrehungen
F Quelques tours uniquement
NL Slechts enkele slagen
I Solo qualche giro
E Sólo algunas vueltas
PT Noções básicas
S Endast några varv
FIN Vain muutama kierros
EST Ainult mõni pööre
LAT Tikai daži apgriezieni
LIT Tik keli pasukimai
PL Wystarczy kilka obrotów
RU Достаточно нескольких оборотов
CZ Pouze několik otáček
SK Len niekoľko otáčok
SLO Le nekaj obratov

- HR** Samo nekoliko okreta
HU Csak néhány fordítás
GR Μόνο μερικές στροφές
TR Yalnız birkaç kez çevirm
中文 只有几个转向
한국어 두 세번만
日本語 数回転のみ
ไทย หมุนเพียงไม่กี่รอบ

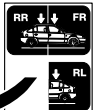
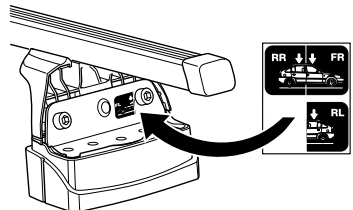

2

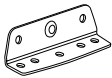

04 x 4

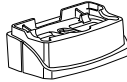

43 x 4

12 mm x 8



x 1

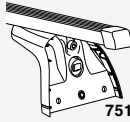

751

ONLY FOR: MERCEDES Viano,
4-dr Bus, 96-03, 04-
MERCEDES Viano Marco Polo,
4-dr Bus, 96-03, 04-
MERCEDES Vito,
4-dr Van, 96-03, 04-

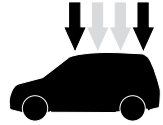

04

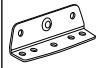

43

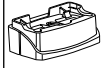

04

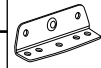

43

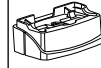

04

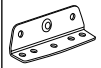

43

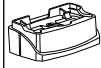

04

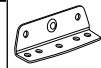

43

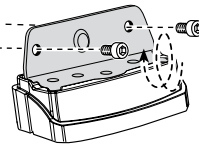
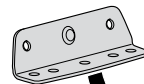
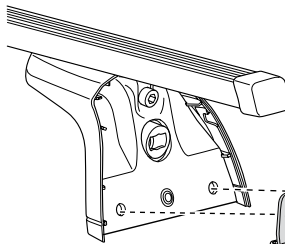
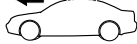
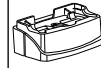

i

i

- GB** Only a few turns
D Nur wenige Umdrehungen
F Quelques tours uniquement
NL Slechts enkele slagen
I Solo qualche giro
E Sólo algunas vueltas
PT Noções básicas
S Endast några varv
FIN Vain muutama kierros
EST Ainult mõni pööre
LAT Tikai dažī apgriezieni
LIT Tik keli pasukimai
PL Wystarczy kilka obrotów
RU Достаточно нескольких оборотов
CZ Pouze několik otáček
SK Len niekoľko otáčok
SLO Le nekaj obratov

- HR** Samo nekoliko okreta
HU Csak néhány fordítás
GR Μόνο μερικές στροφές
TR Yalnız birkaç kez çevirm
中文 只有几个转向
한국어 두 세번만
日本語 数回転のみ
ไทย หมุนเพียงไม่กี่รอบ

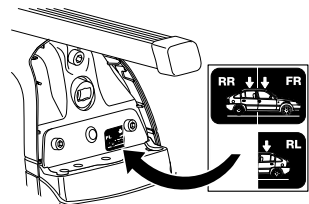

3

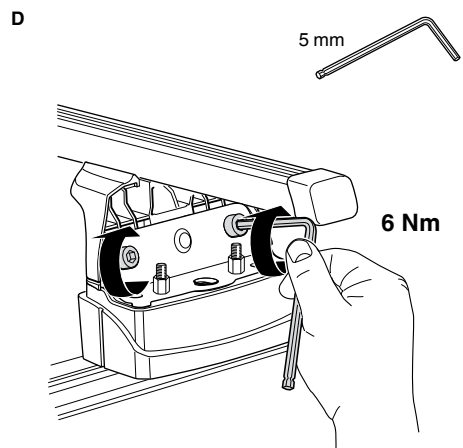
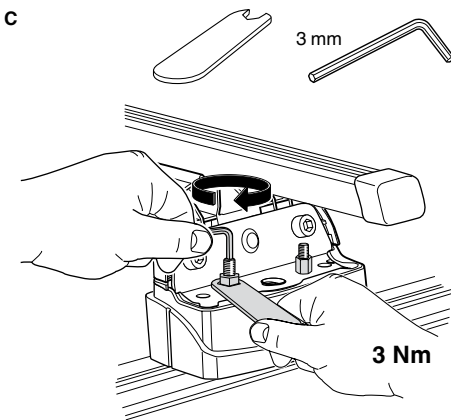
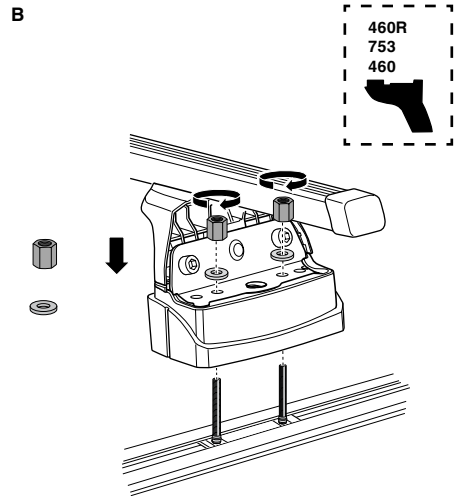
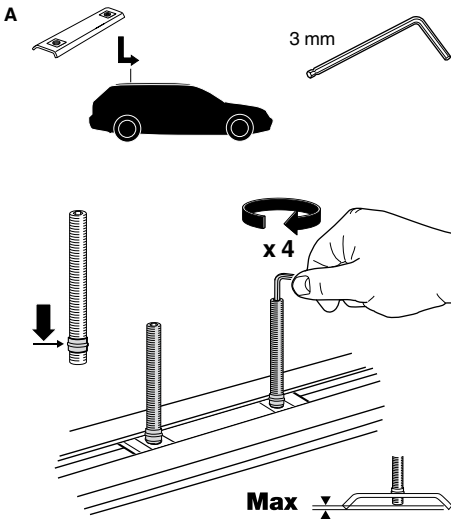
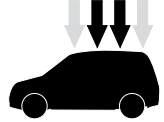
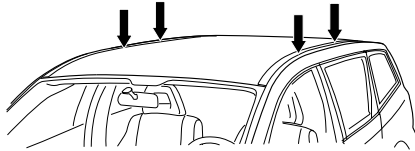
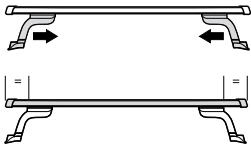
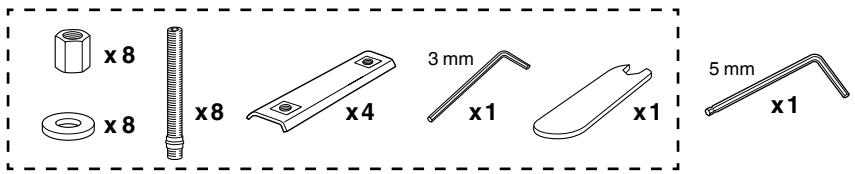

3

x 8



x 8



x 8

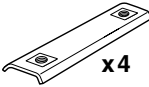

x 4

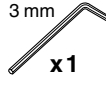

3 mm

x 1



x 1

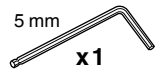

5 mm

x 1

**ONLY FOR: MERCEDES Viano, 4-dr Bus, 96-03, 04-
 MERCEDES Viano Marco Polo, 4-dr Bus, 96-03, 04-
 MERCEDES Vito, 4-dr Van, 96-03, 04-**

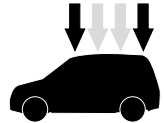
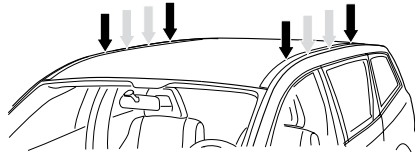
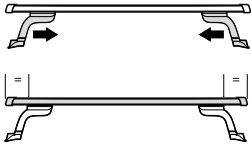
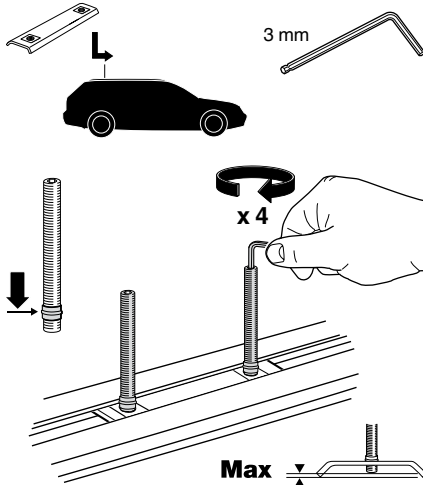
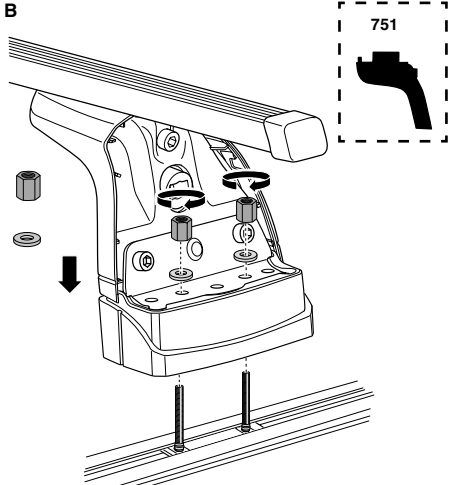
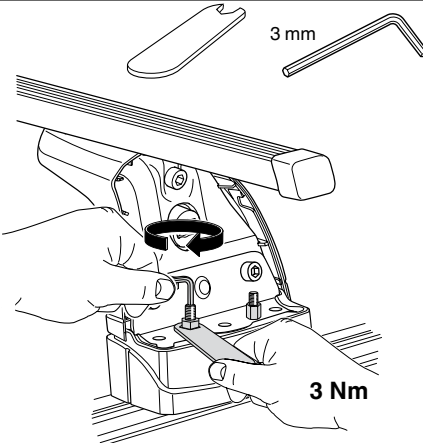
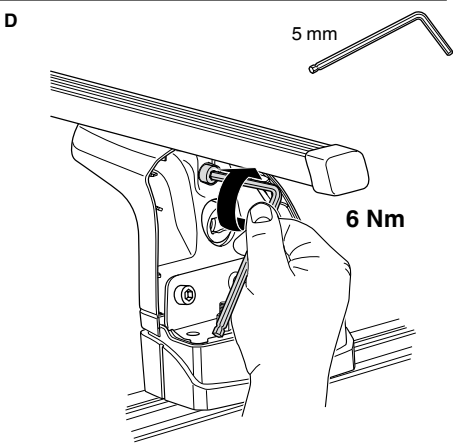
**A****B****C****D**

4



753 **x4**



x4



x1

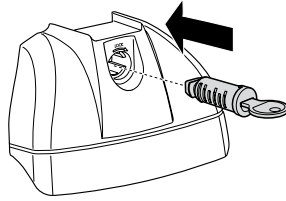

460/460R **x4**



x4

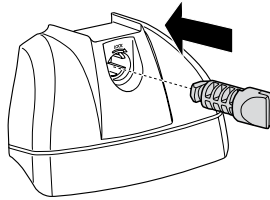

751 **x4**



x4



x1

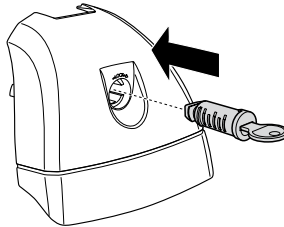

5

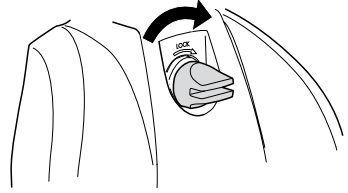
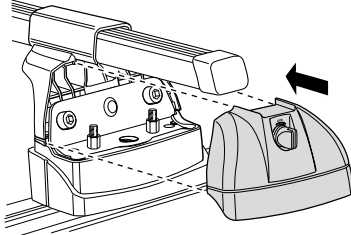
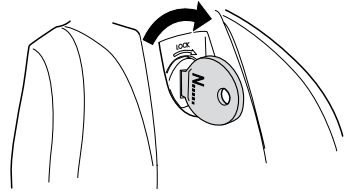
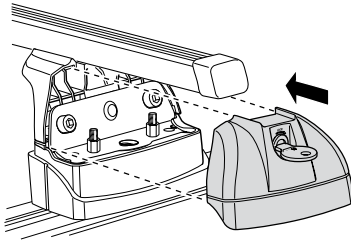

5 mm

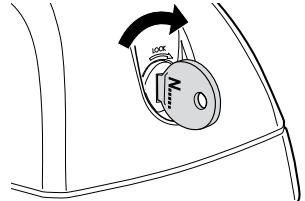
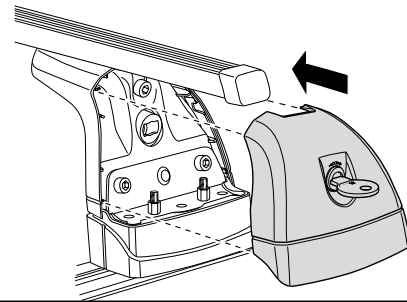
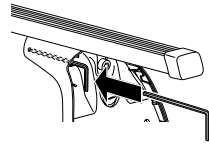
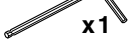

6

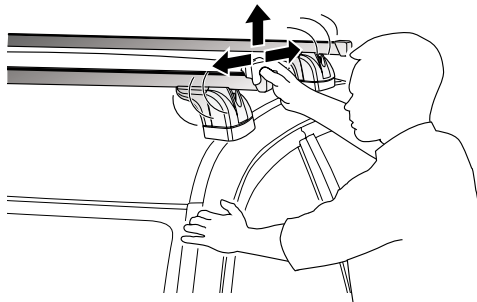

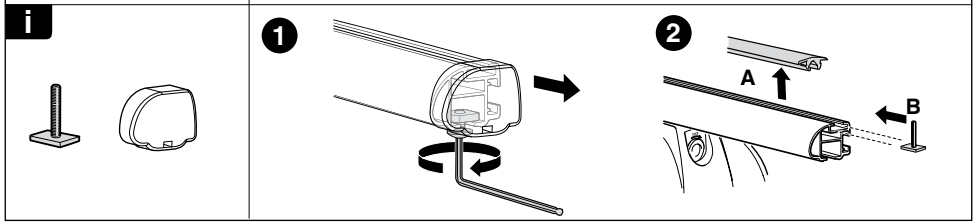
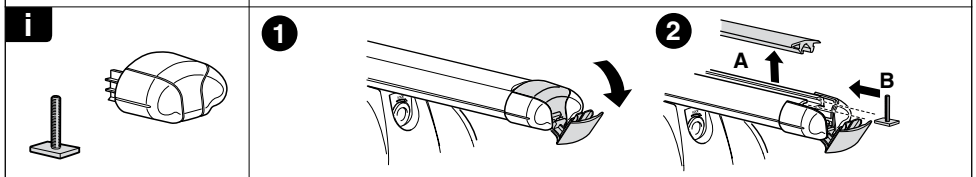
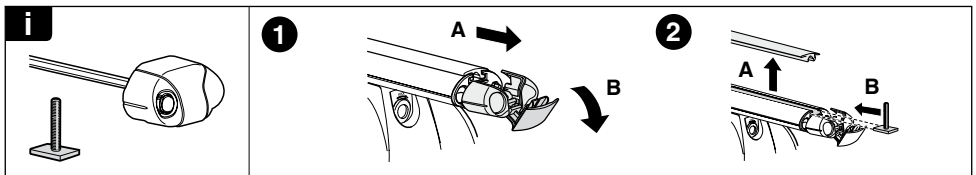
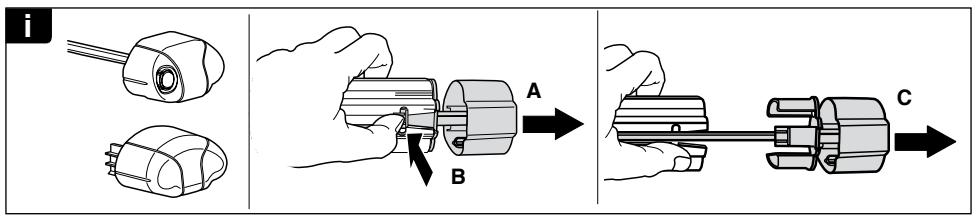
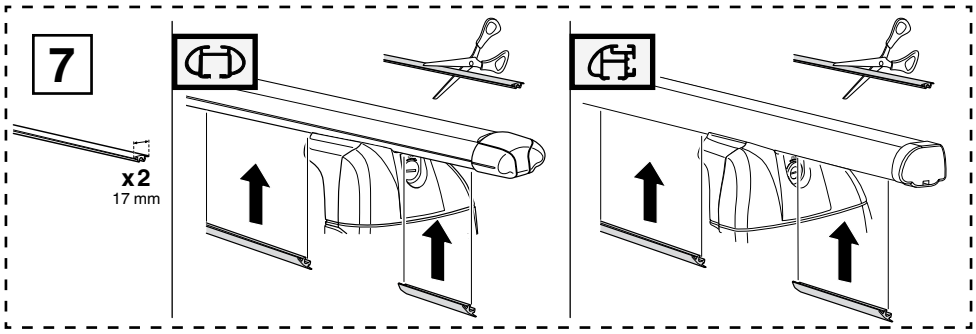

THULE
SWEDEN
**ONE
KEY
SYSTEM**

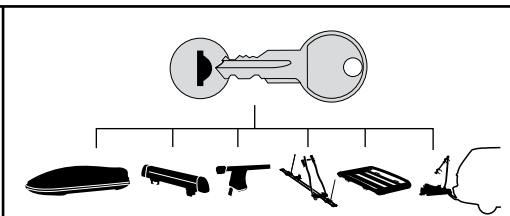

- 544 (x4)
- 596 (x6)
- 588 (x8)
- NA 510 (x10)
- EUR 452 (x12)
- ASIA