

Kit 3061

HYUNDAI i30, 5-dr Hatchback, 07–

KIA Cee'd, 5-dr Hatchback, 07–

KIA ProCee'd, 3-dr Hatchback, 08–

This Kit is only for vehicles with fixpoint mounting.

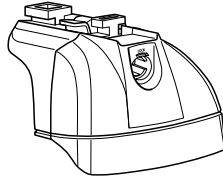

460R
753

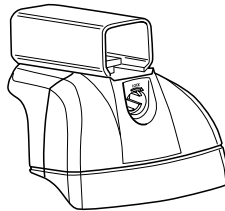
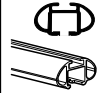

460

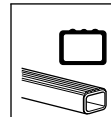

Kit



753



x4



x4



x4



x8

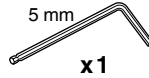

x1



x4



x1

460R

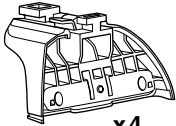

x4



x4



x4



x8

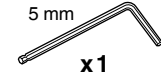

x1



x4

460



x4



x4



x4



x8

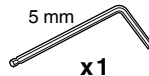

x1



x4

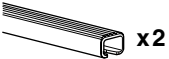

x2



x2

17 mm



x2

23 mm

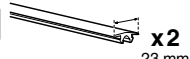

x2

23 mm

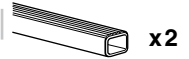

x2

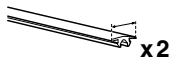

x2

23 mm

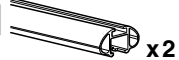

x2

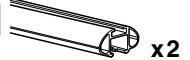

x2

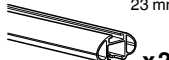

x2



x4



x4



x4

1



753/460R



460

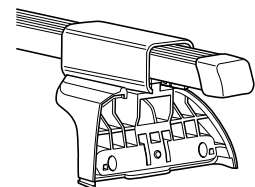
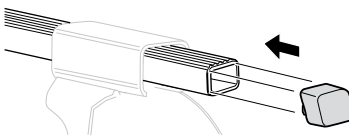
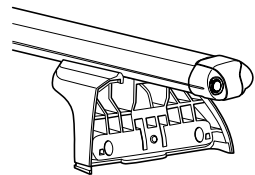
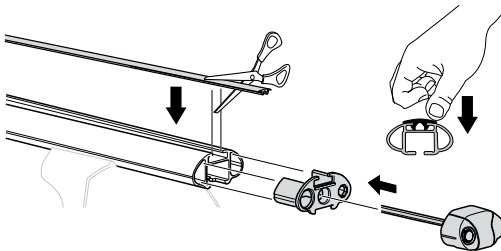
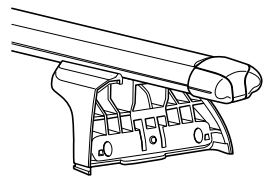
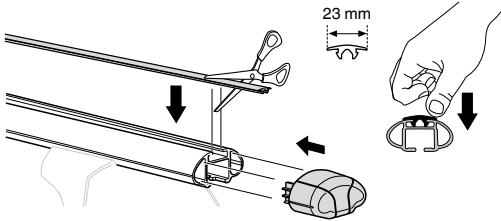
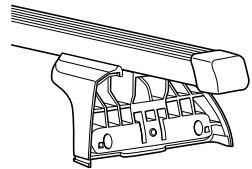
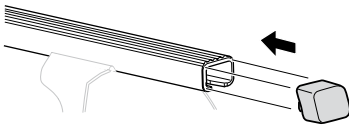
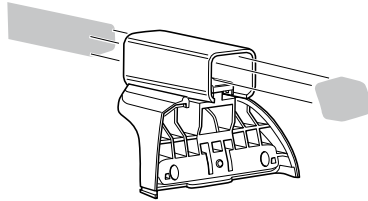
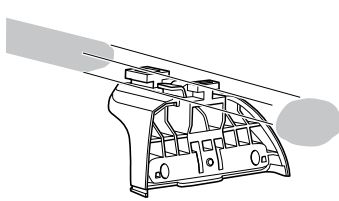

2

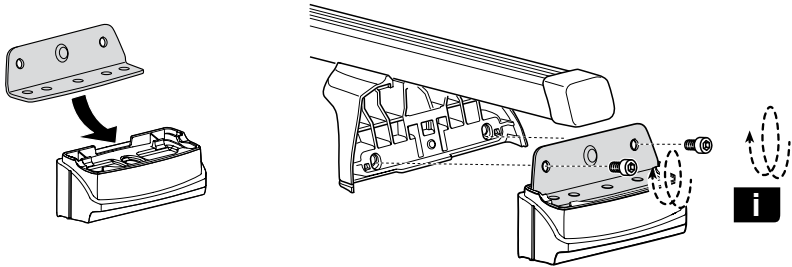
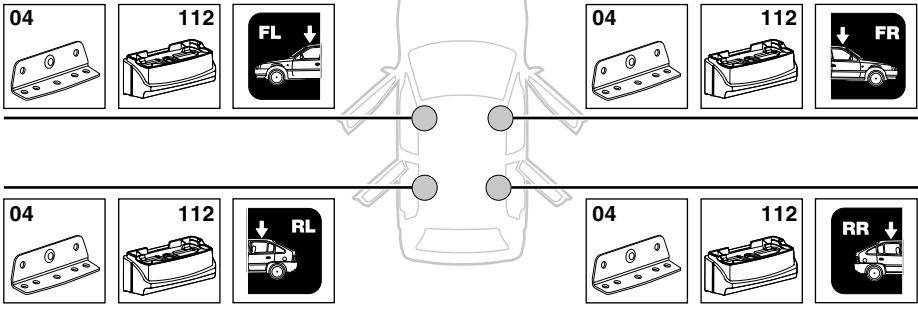
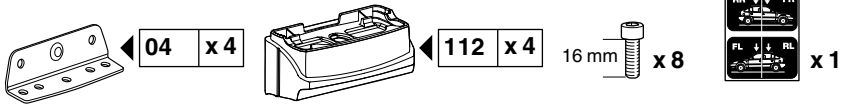

i	GB Only a few turns	EST Ainult mõni pööre	HR Samo nekoliko okreta
	D Nur wenige Umdrehungen	LAT Tikai dažī apgriezieni	HU Csak néhány fordítás
	F Quelques tours uniquement	LIT Tik keli pasukimai	GR Μόνο μερικές στροφές
	NL Slechts enkele slagen	PL Wystarczy kilka obrotów	TR Yalnız birkaç kez çevirm
	I Solo qualche giro	RU Достаточно нескольких оборотов	中文 只有几个转向
	E Sólo algunas vueltas	CZ Pouze několik otáček	한국어 두 세번만
	PT Noções básicas	SK Len niekoľko otáčok	日本語 数回転のみ
	S Endast några varv	SLO Le nekaj obratov	ไทย หมุนเพียงไม่กี่รอบ
	FIN Vain muutama kierros		

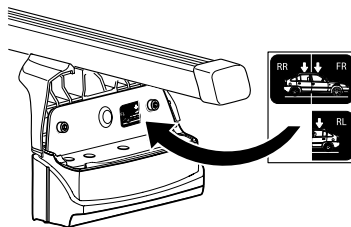

3

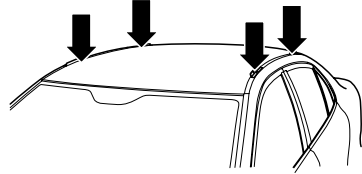
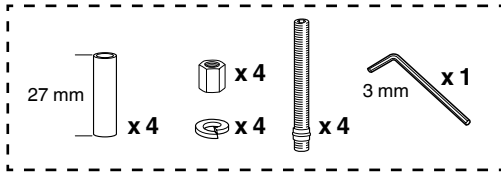

A

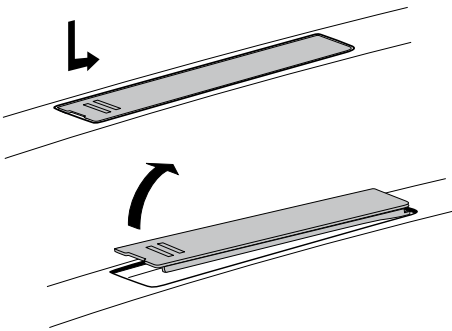

B

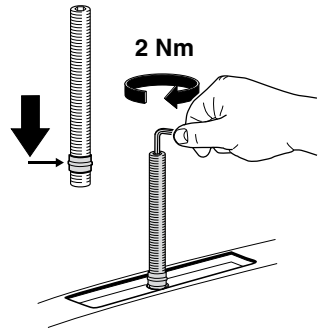

C

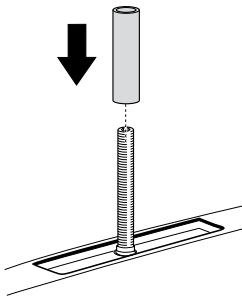

D

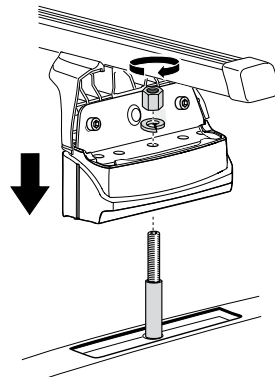

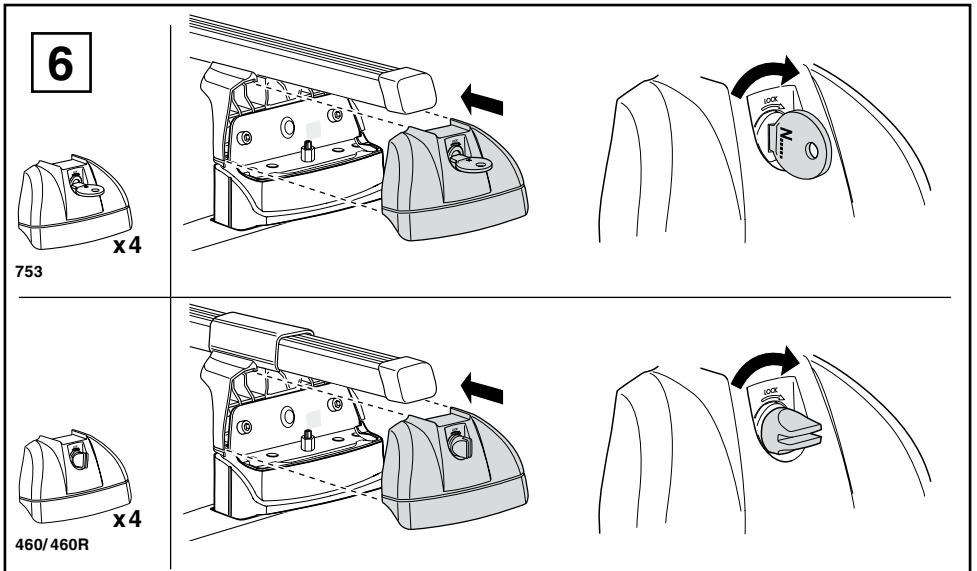
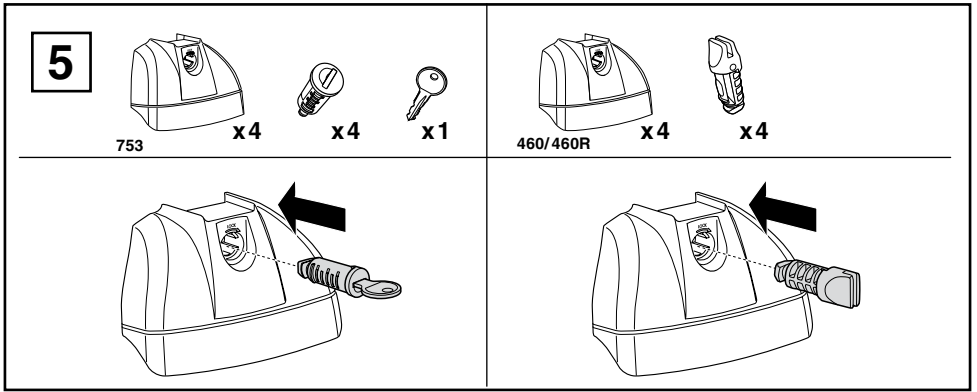
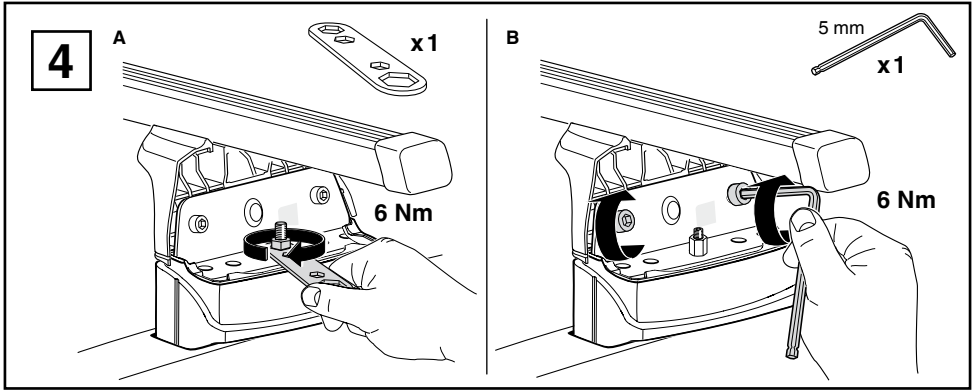

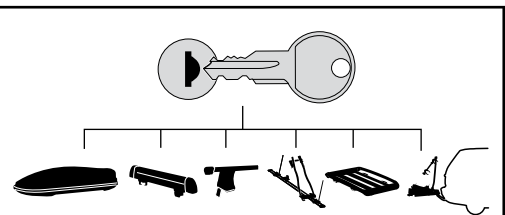
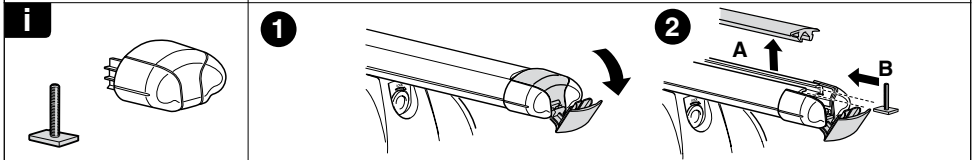
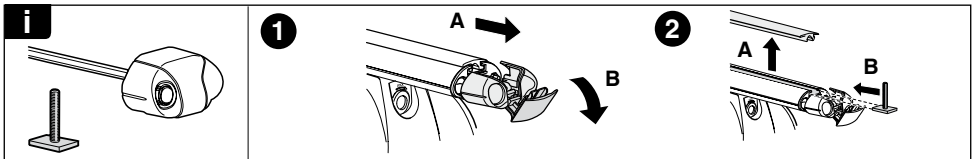
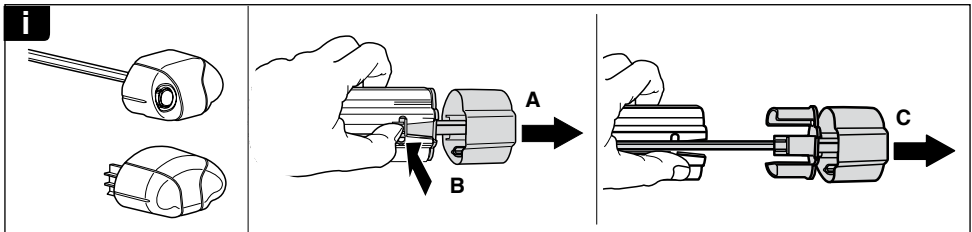
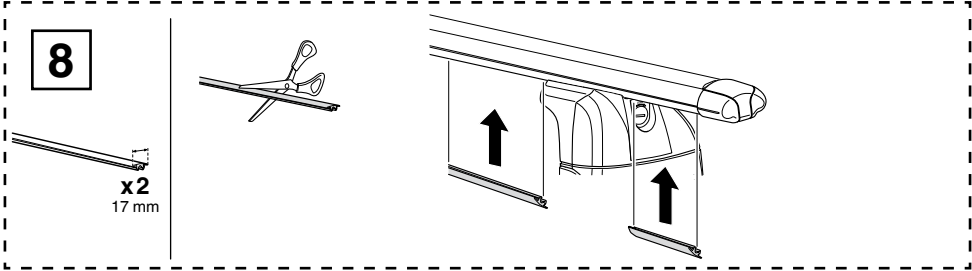
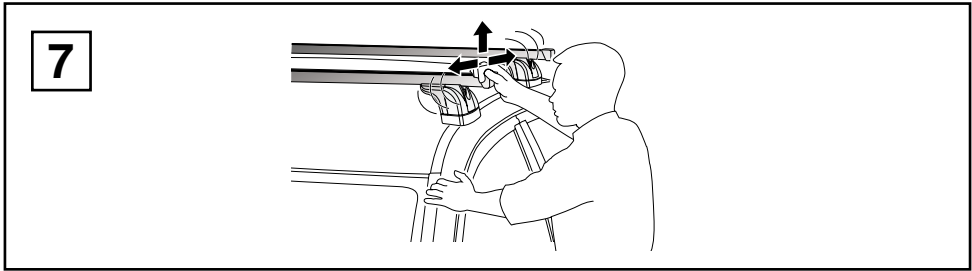

- 544 (x4)
- 596 (x6)
- 588 (x8)
- NA 510 (x10)
- EUR 452 (x12)

WW Thule Sweden AB, Box 69, 330 33 Hillerstorp, SWEDEN
 NA Thule Inc., 42 Silvermine Road, Seymour, Connecticut 06483, USA

info@thule.com
 customer.service@thule.com

www.thule.com