

Kit 3059

NISSAN X-Trail, 5-dr SUV, 07-

This Kit is only for vehicles with fixpoint mounting.



460R
753



460



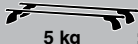

 $xx \text{ kg}$
 $xx \text{ lbs}$



 5 kg
 11 lbs

$=$

Max.
100kg

Max.
220 lbs

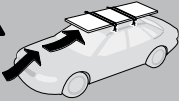





80 km/h
 50 Mph

130 km/h
 80 Mph

40 km/h
 25 Mph

km/h
Mph

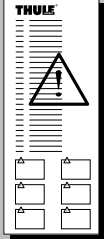

$+$

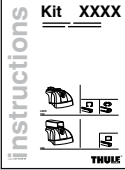

Kit XXXX





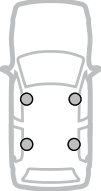

A



B



C

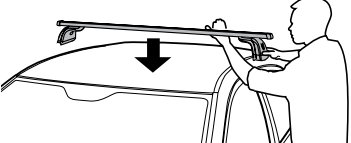



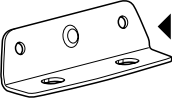

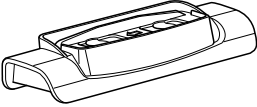

12 x 4

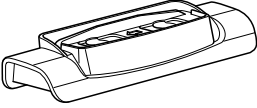

LH x 2



RH x 2



x 1

51341



x 8

51336



x 8

Kit

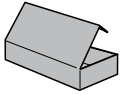

753

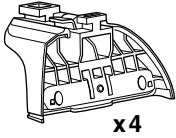

x4



x4



x4



x8

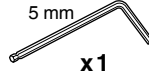

x1



x4



x1

460R

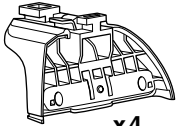

x4



x4



x4



x8

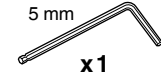

x1



x4

460

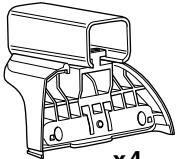

x4



x4



x4



x8

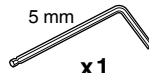

x1



x4

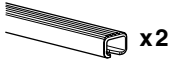

x2



x2

17 mm

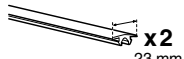

x2

23 mm

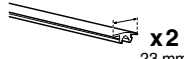

x2

23 mm

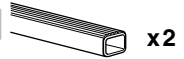

x2

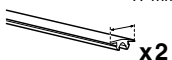

x2

23 mm

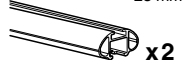

x2



x4

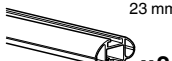

x2



x4



x4

1

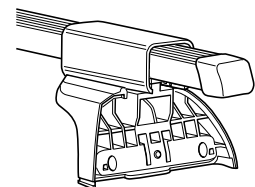
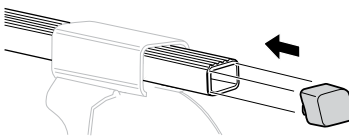
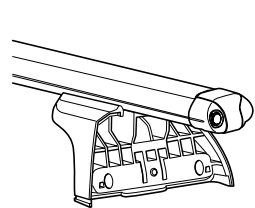
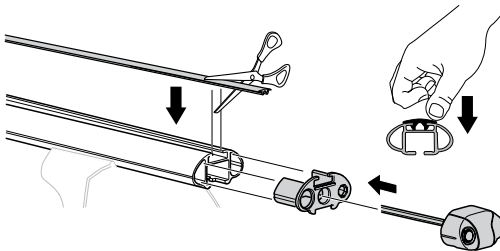
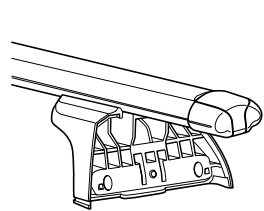
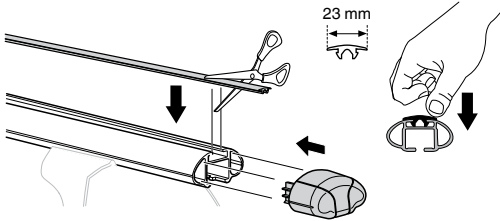
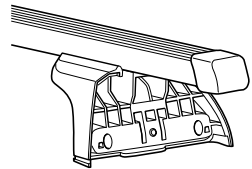
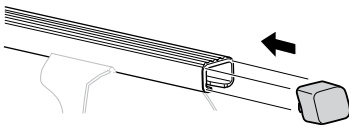
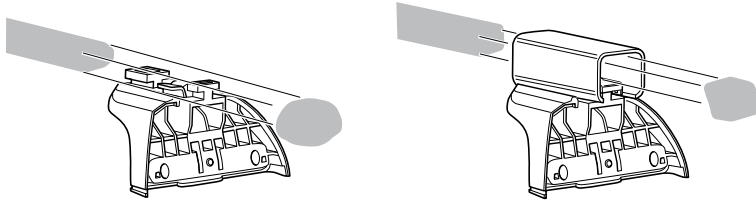
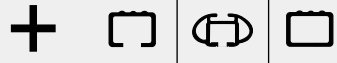
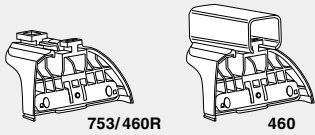

2

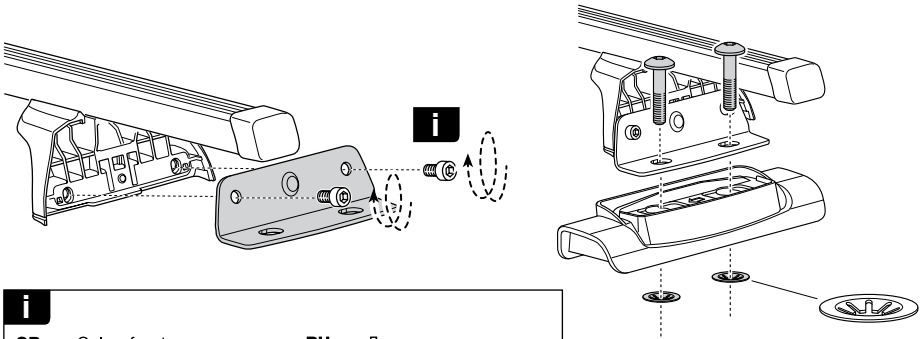
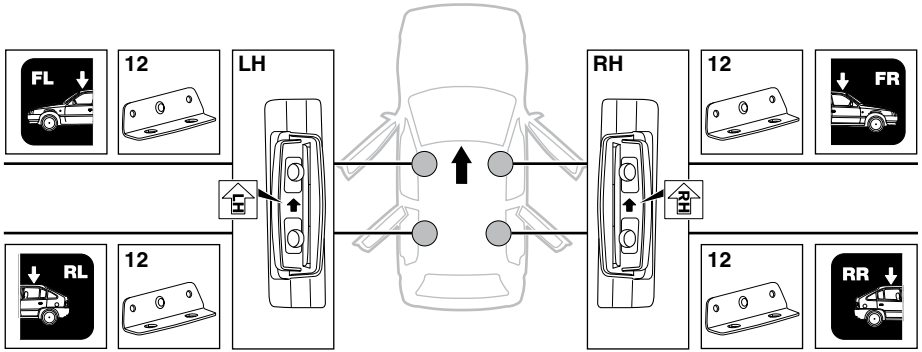
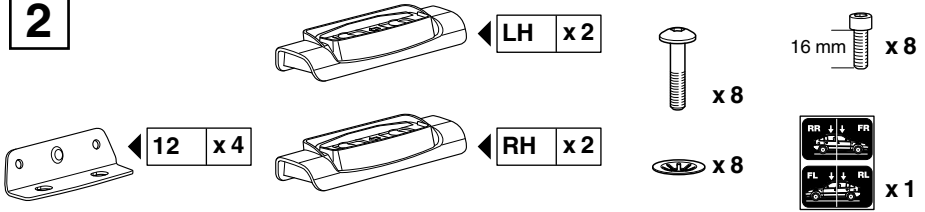

i

- | | | | |
|------------|---------------------------|------------|--------------------------------|
| GB | Only a few turns | RU | Достаточно нескольких оборотов |
| D | Nur wenige Umdrehungen | CZ | Pouze několik otáček |
| F | Quelques tours uniquement | SK | Len niekoľko otáčok |
| NL | Slechts enkele slagen | SLO | Le nekaj obratov |
| I | Solo qualche giro | HR | Samo nekoliko okreta |
| E | Sólo algunas vueltas | HU | Csak néhány fordítás |
| PT | Noções básicas | GR | Μόνο μερικές στροφές |
| S | Endast några varv | TR | Yalnız birkaç kez çevirm |
| FIN | Vain muutama kierros | 中文 | 只有几个转向 |
| EST | Ainult mõni pööre | 한국어 | 두 세번만 |
| LAT | Tikai dažī apgriezieni | 日本語 | 数回転のみ |
| LIT | Tik keli pasukimai | ไทย | หมุนเพียงไม่กี่รอบ |
| PL | Wystarczy kilka obrotów | | |

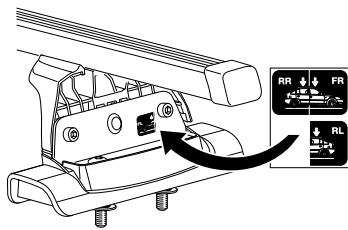

3

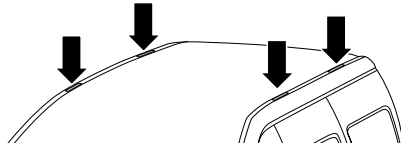
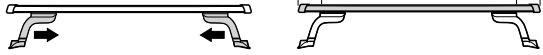
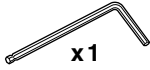

A

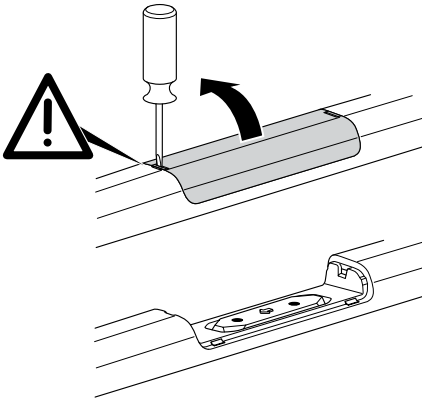

B

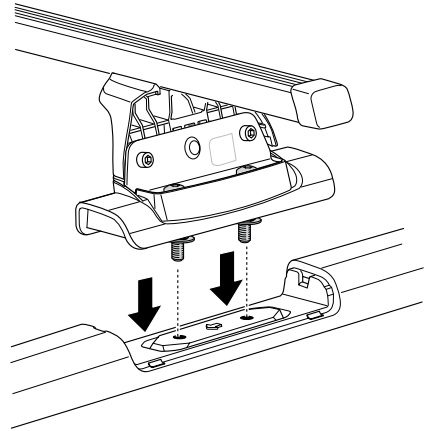

C

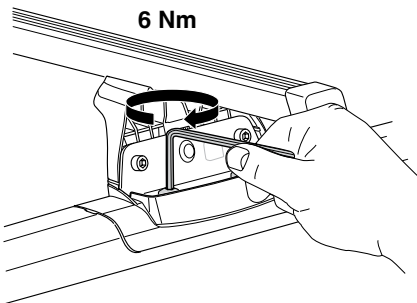

D

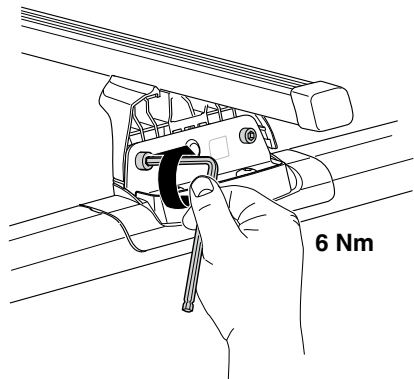

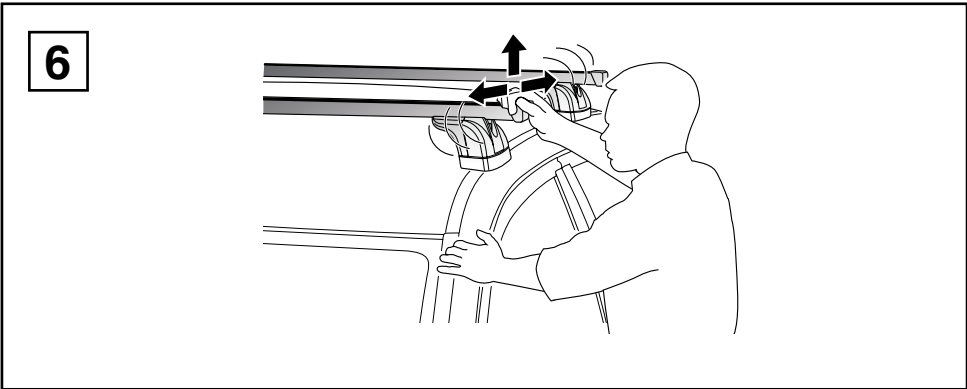
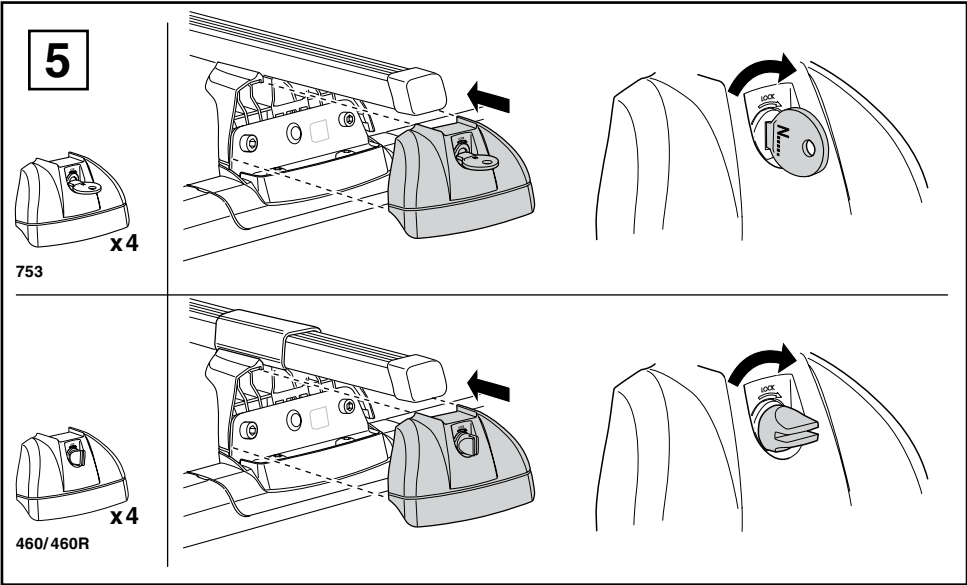
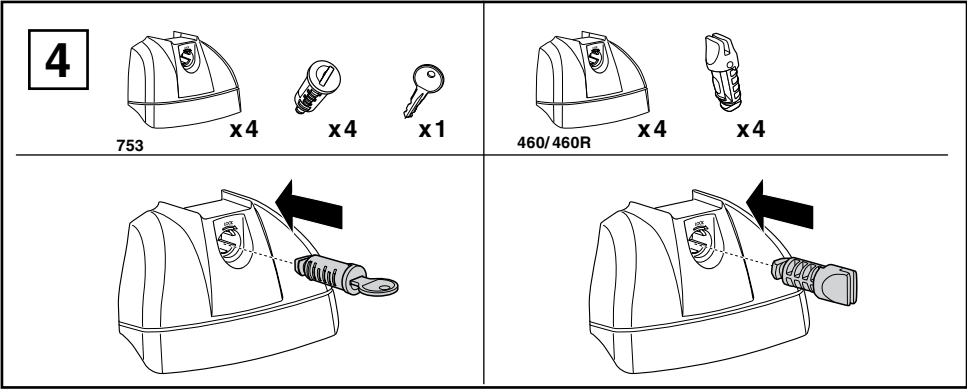

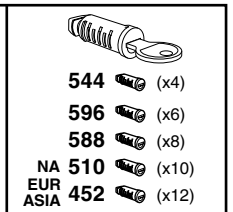
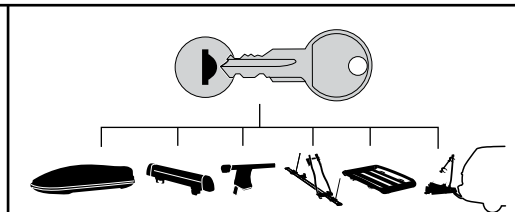
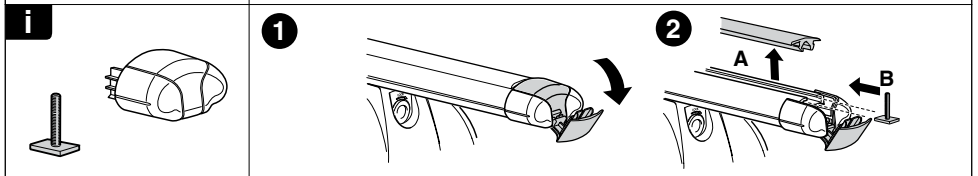
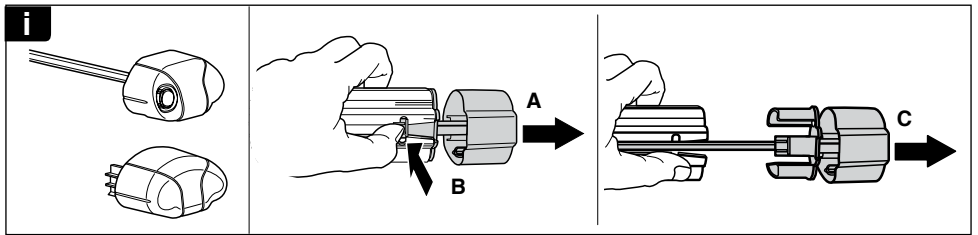

WW ▶ Thule Sweden AB, Box 69, 330 33 Hillerstorp, SWEDEN
 NA ▶ Thule Inc., 42 Silvermine Road, Seymour, Connecticut 06483, USA

info@thule.com
 customer.service@thule.com

www.thule.com

506-3059-02