

Kit 3021

- FIAT Doblo**, 3-dr Van, 00-03, 04-05, 06–
- FIAT Doblo**, 4-dr Van, 00-03, 04-05, 06–
- FIAT Doblo**, 5-dr Van, 00-03, 04-05, 06–
- FIAT Doblo Maxi**, 4-dr Van, 08–
- FORD Tourneo Connect**, 5-dr Bus, 03–
- FORD Transit Connect**, 4-dr Van, 03–
- NISSAN Kubistar**, 5-dr Van, 04–
- RENAULT Kangoo**, 5-dr Van, 98-02, 03-07, 08–

This Kit is only for vehicles with fixpoint mounting.

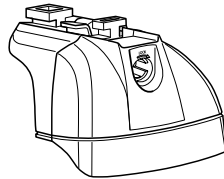

460R
753

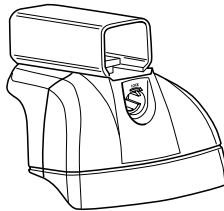
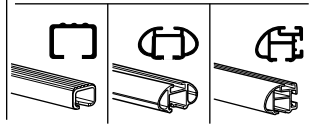

460

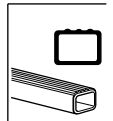

Kit



753

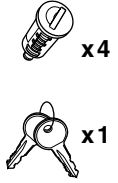
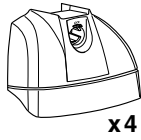

460R

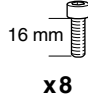
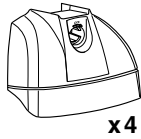
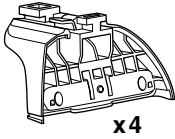

460

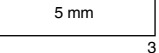
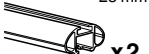
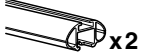
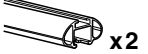
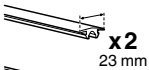
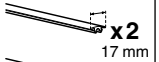
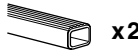
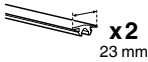
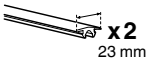
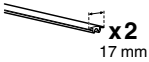
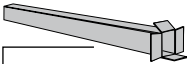
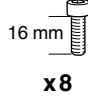
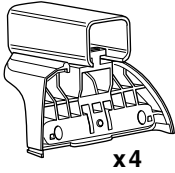

1



753/460R



460

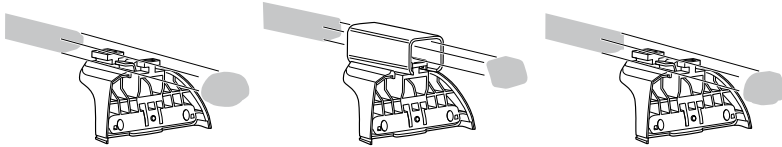

x4

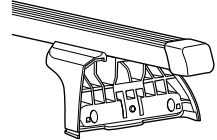
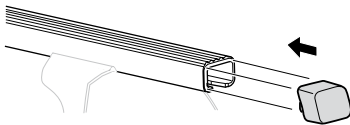

x4

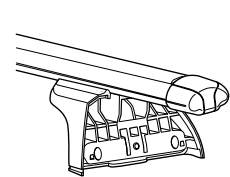
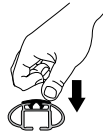
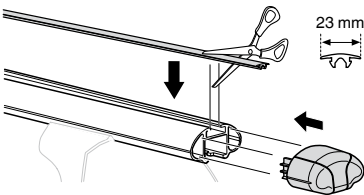

x4

x4

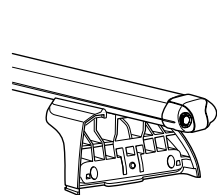
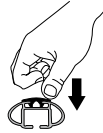
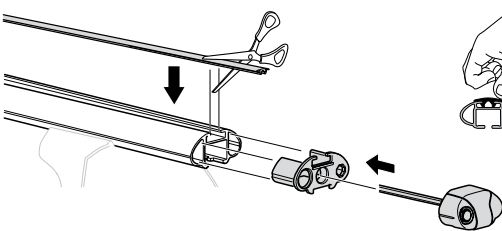

x4

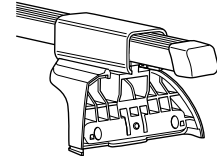
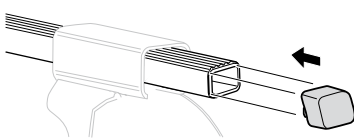

x2

x2

x4

x4

x1
5 mm

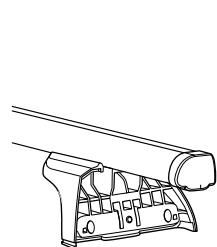
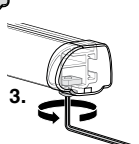
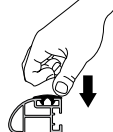
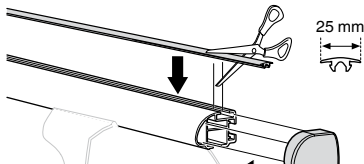

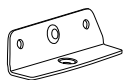
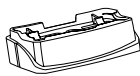
2**01** x 4**26** x 2**27** x 216 mm  x 8

x 1

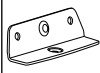
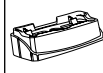
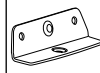
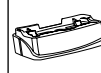
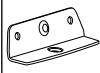
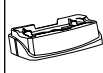
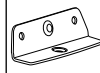
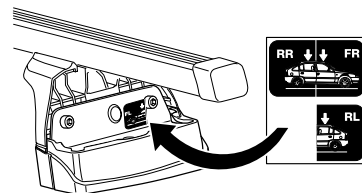
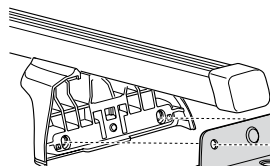
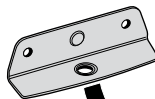
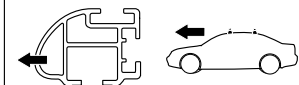
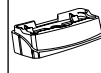
01**27****01****26****01****26****01****27****GB** Only a few turns**D** Nur wenige Umdrehungen**F** Quelques tours uniquement**NL** Slechts enkele slagen**I** Solo qualche giro**E** Sólo algunas vueltas**PT** Noções básicas**S** Endast några varv**FIN** Vain muutama kierros**EST** Ainult mõni pööre**LAT** Tikai dažī apgriezieni**LIT** Tik keli pasukimai**PL** Wystarczy kilka obrotów**RU** Достаточно нескольких

оборотов

CZ Pouze několik otáček**SK** Len niekoľko otáčok**SLO** Le nekaj obratov**HR** Samo nekoliko okreta**HU** Csak néhány fordítás**GR** Μόνο μερικές στροφές**TR** Yalnız birkaç kez çevirm**中文** 只有几个转向**한국어** 두 세번만**日本語** 数回転のみ**ไทย** หมุนเพียงไม่กี่รอบ

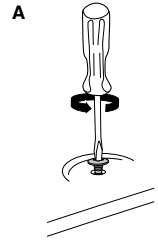
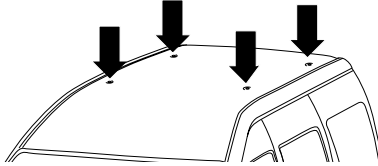
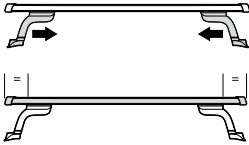
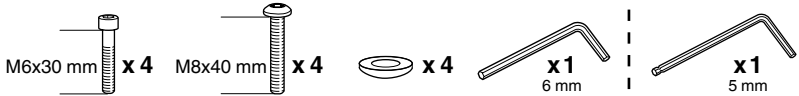
3

B **FIAT Doblo**, 3-dr Van, 00-03, 04-05, 06-
FIAT Doblo, 4-dr Van, 00-03, 04-05, 06-
FIAT Doblo, 5-dr Van, 00-03, 04-05, 06-
FIAT Doblo Maxi, 4-dr Van, 08-

FORD Tourneo Connect, 5-dr Bus, 03-
FORD Transit Connect, 4-dr Van, 03-
NISSAN Kubistar, 5-dr Van, 04-
RENAULT Kangoo, 5-dr Van, 98-02, 03-07, 08-

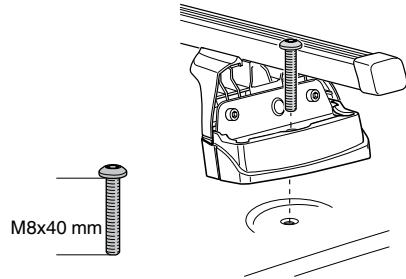
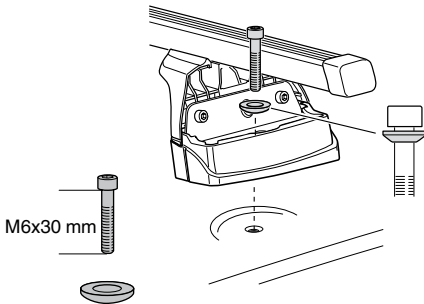
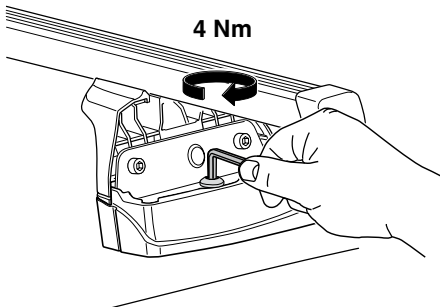
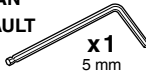
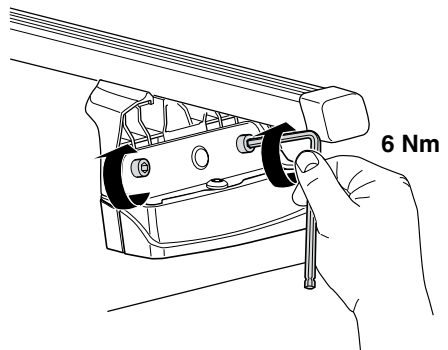

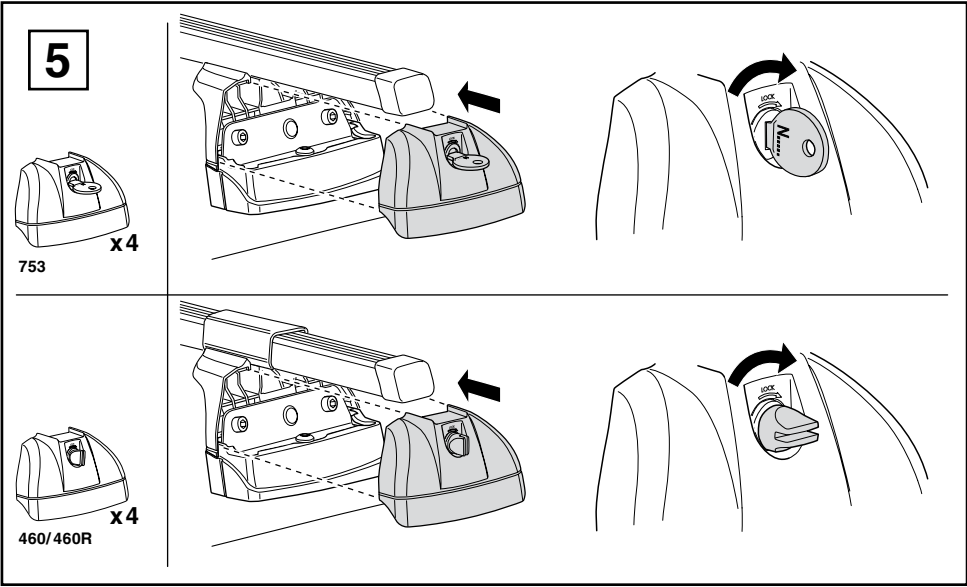
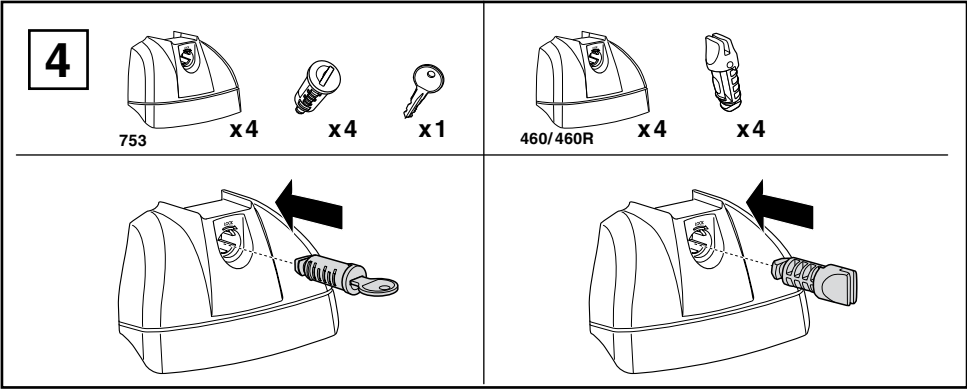

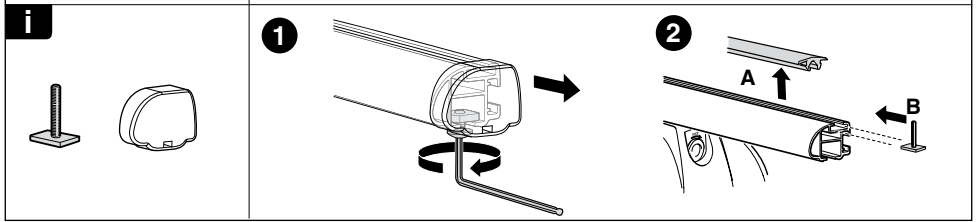
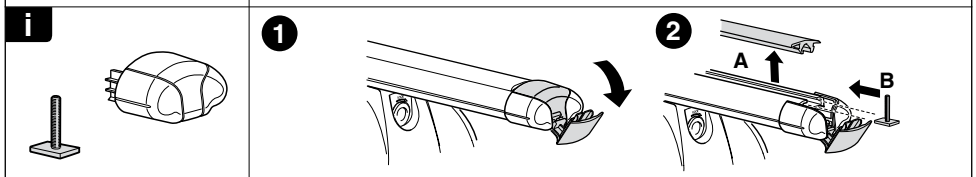
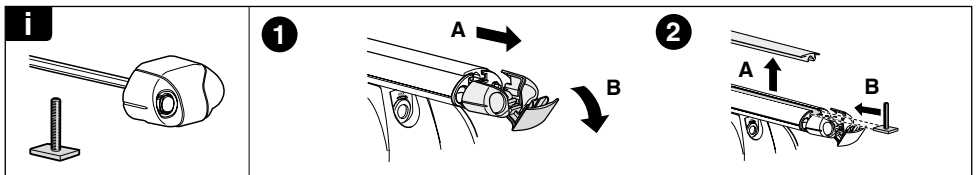
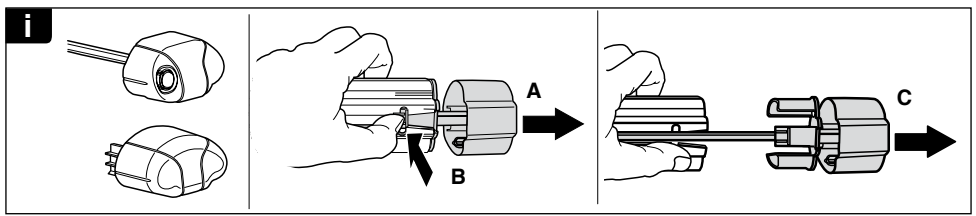
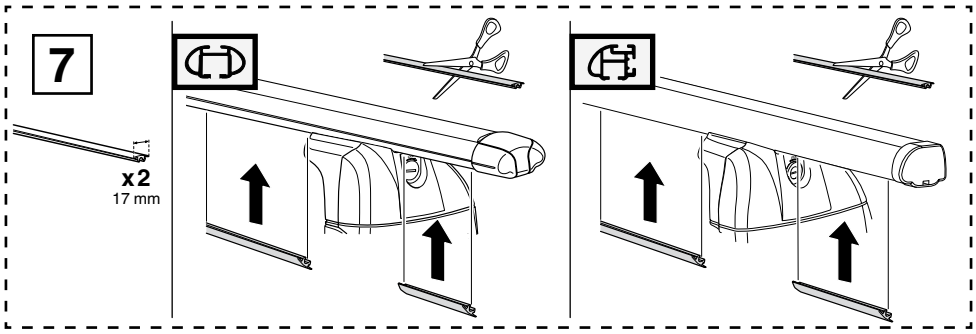
**C** **FIAT****FORD
NISSAN
RENAULT****D**



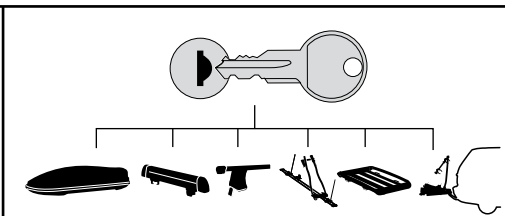

THULE
SWEDEN
**ONE
KEY
SYSTEM**



- 544**  (x4)
- 596**  (x6)
- 588**  (x8)
- NA 510**  (x10)
- EUR ASIA 452**  (x12)