

Kit 1540

CHEVROLET Malibu, 4-dr Sedan, 08-
SATURN Aura, 4-dr Sedan, 07-

480R
754

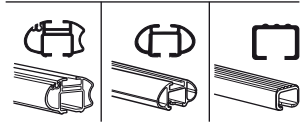
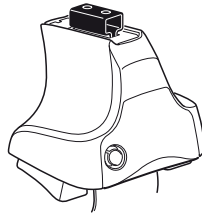

480

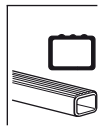
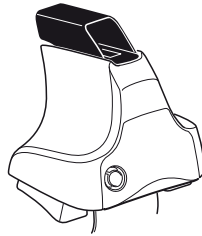

750

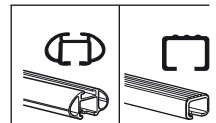
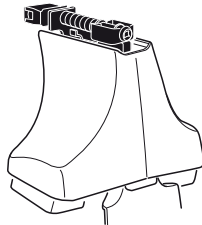

Kit

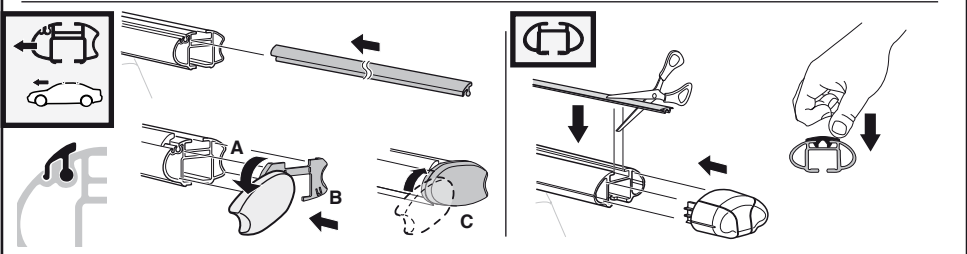
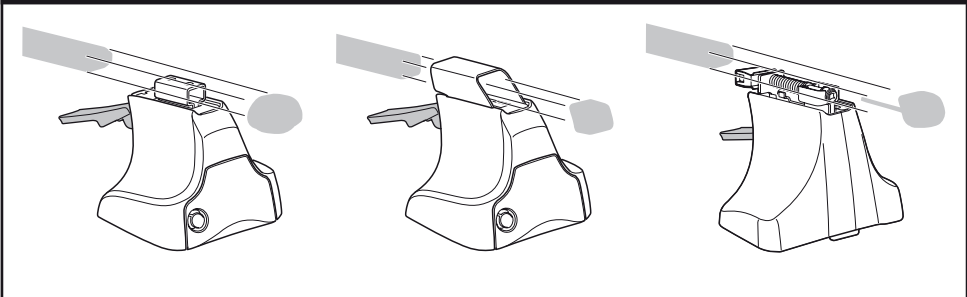

3



754

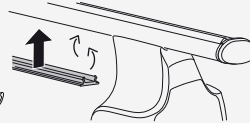
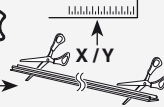

750



1

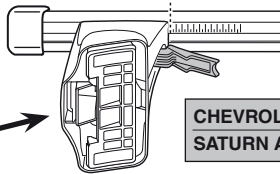
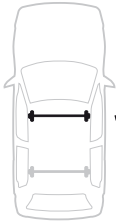

2

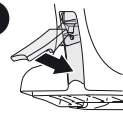

CHEVROLET Malibu, 4-dr Sedan, 08-
SATURN Aura, 4-dr Sedan, 07-

X

38

38

1

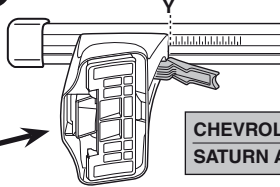

2

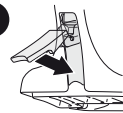

CHEVROLET Malibu, 4-dr Sedan, 08-
SATURN Aura, 4-dr Sedan, 07-

Y

34,5

34,5



480R



480

1

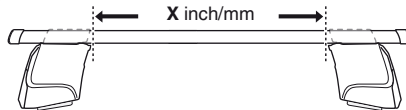
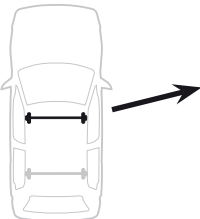

2

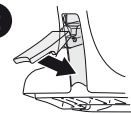

CHEVROLET Malibu, 4-dr Sedan, 08
SATURN Aura, 4-dr Sedan, 07-

X inch

X mm

40 1/2"

1031 mm

40 1/2"

1031 mm

1

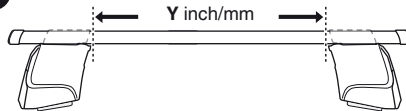
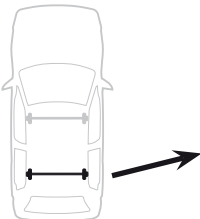

2

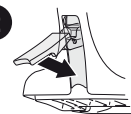

CHEVROLET Malibu, 4-dr Sedan, 08-
SATURN Aura, 4-dr Sedan, 07-

Y inch

Y mm

39 1/8"

996 mm

39 1/8"

996 mm

4

CHEVROLET Malibu, 4-dr Sedan, 08–
SATURN Aura, 4-dr Sedan, 07–

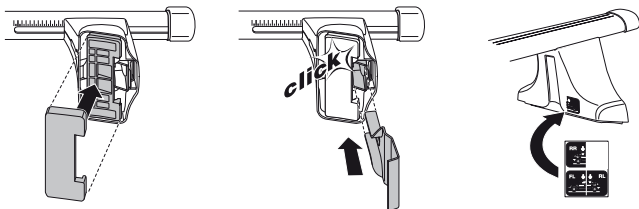
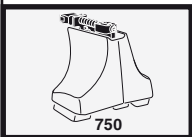
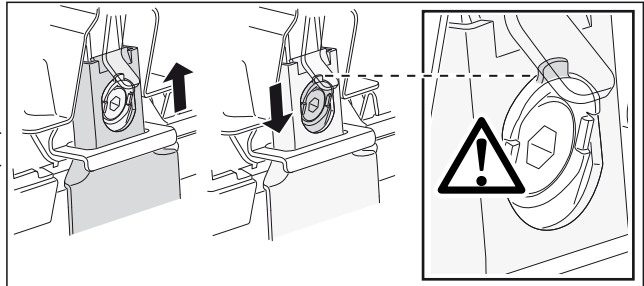
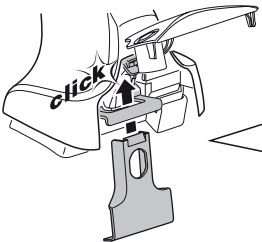
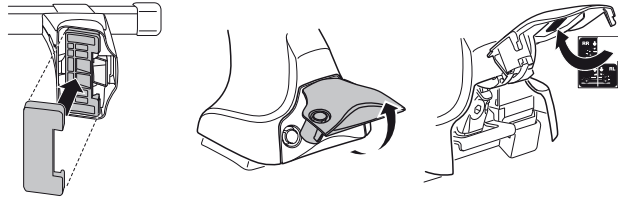
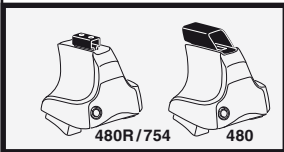
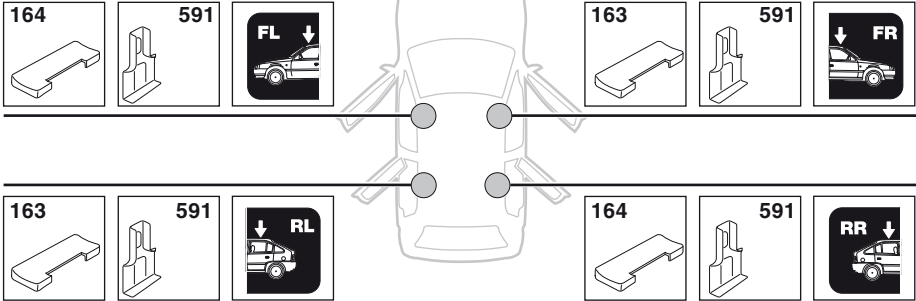

5

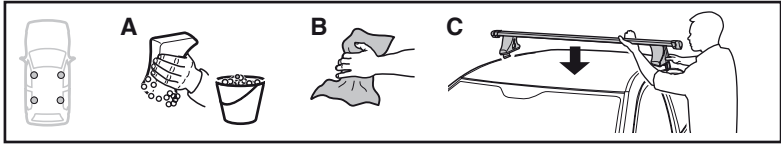

	X mm	Y mm	X inch	Y inch
CHEVROLET Malibu , 4-dr Sedan, 08–	230 mm	673 mm	9"	26 1/2"
SATURN Aura , 4-dr Sedan, 07–	230 mm	673 mm	9"	26 1/2"

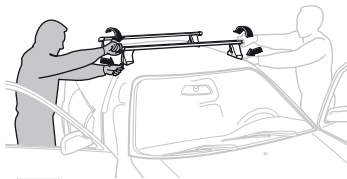
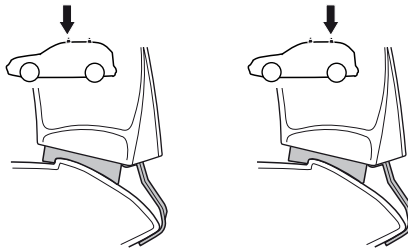
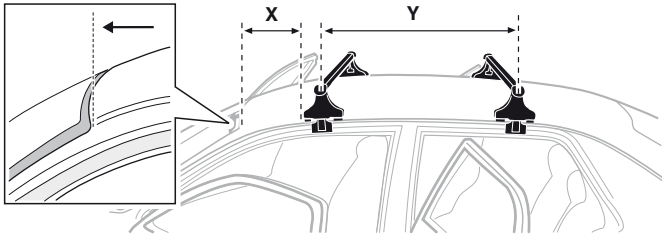

GB/US Tighten alternately

D Die Schrauben abwechselnd anziehen

F Serrer alternativement chaque côté

NL Afwisselend aan de linker- en de rechterkant aandraaien

I Alternare il serraggio delle viti

E Apretar alternativamente

PT Aperte alternadamente

S Dra åt växelvis

FIN Kierrä vuorotellen

EST Pinguldage vaheldumisi

LAT Pielieciet pamišus

LIT Užsukinėkite pakaitomis

PL Śruby dokręcaj naprzemiennie

RU Затягивайте попеременно

CZ Pokręťta bagażníka dokręcaj dokręcaj naprzemiennie.

SK Doťahujte striedavo

SLO Privijajte izmenično.

HR Naizmjenično zategnite

HU Egymástól függetlenül szorítandó

GR Σφίγγετε εναλλάξ

TR Dönüşümlü sıkın

中文 交替拧紧

한국어 번갈아 가며 조이십시오.

日本語 交互に締め付けてください。

ไทย ชั้้นในแบบสลับ

6



480R/754



480

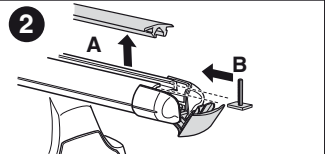
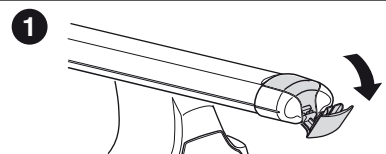
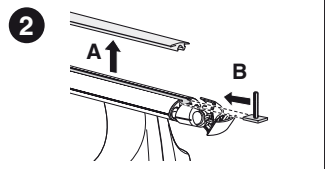
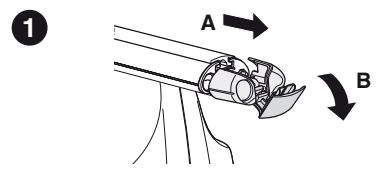
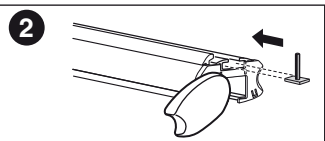
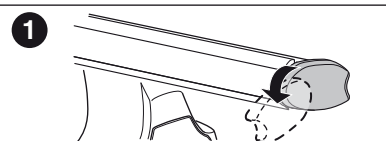
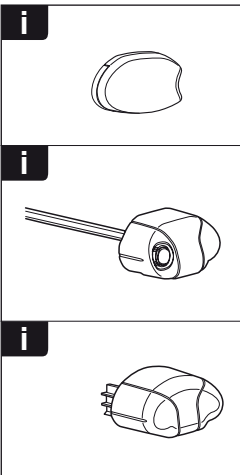
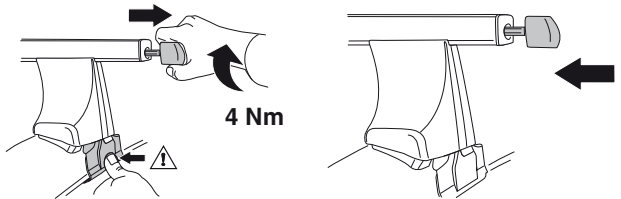
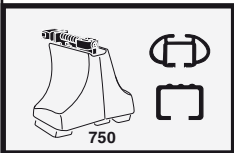
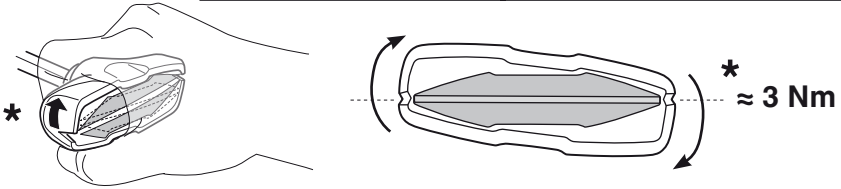
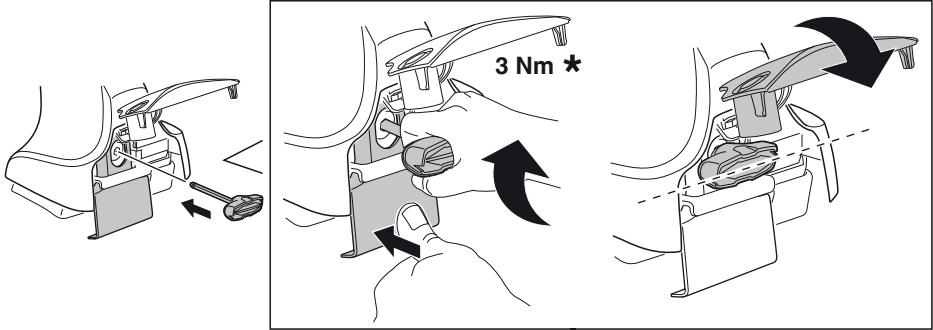

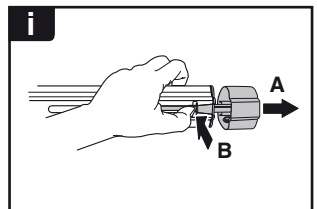
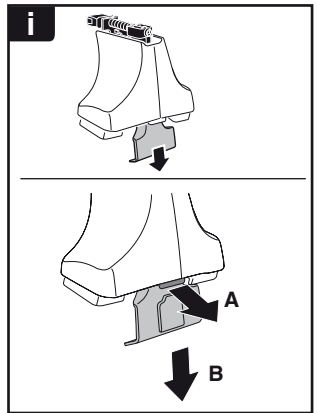
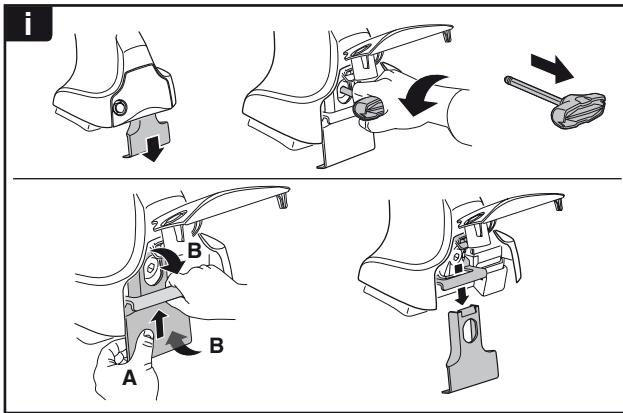
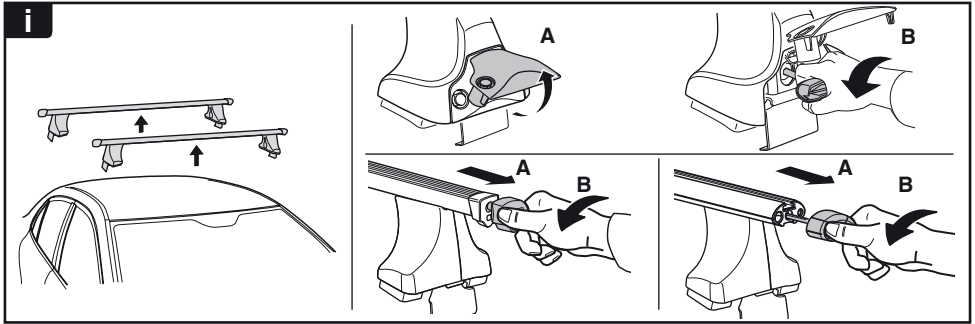

THULE
SWEDEN
**ONE
KEY
SYSTEM**



- 544 (x4)
- 596 (x6)
- 588 (x8)
- NA 510 (x10)
- EUR 452 (x12)
- ASIA

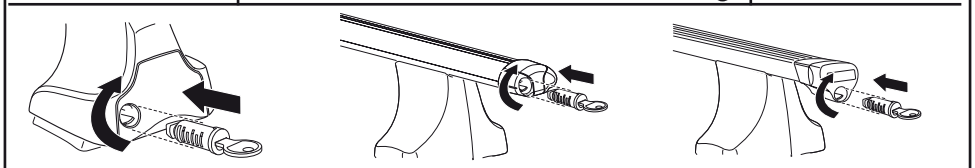

WW ▶ Thule Sweden AB, Box 69, 330 33 Hillerstorp, SWEDEN
 NA ▶ Thule Inc., 42 Silvermine Road, Seymour, Connecticut 06483, USA

info@thule.com
 customer.service@thule.com

www.thule.com