

Kit 1527

JAGUAR XF, 4-dr Sedan, 08- / *09-

*North America

480R
754

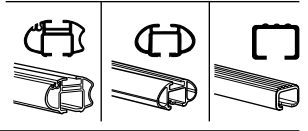
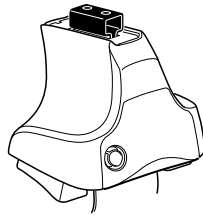

480

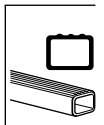
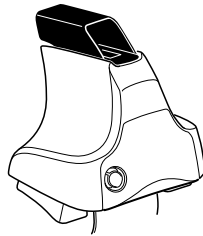

750

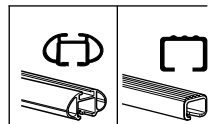
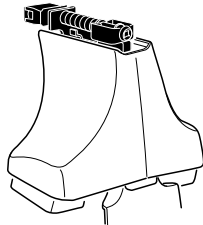

Kit

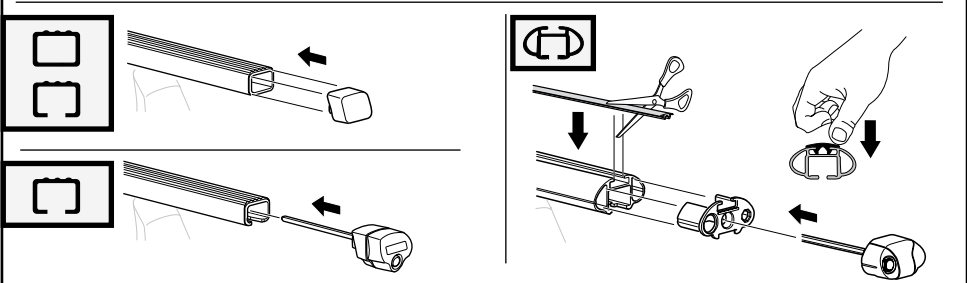
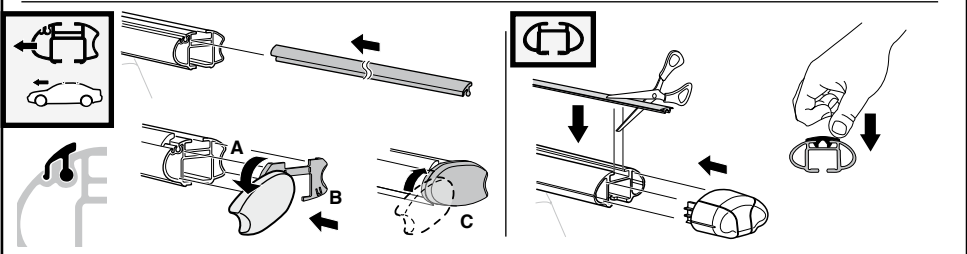
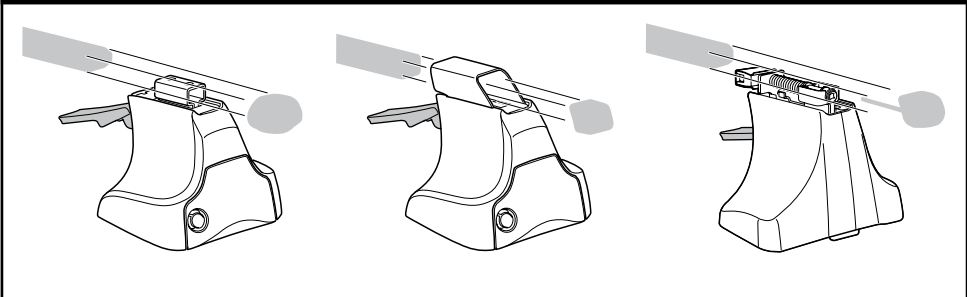
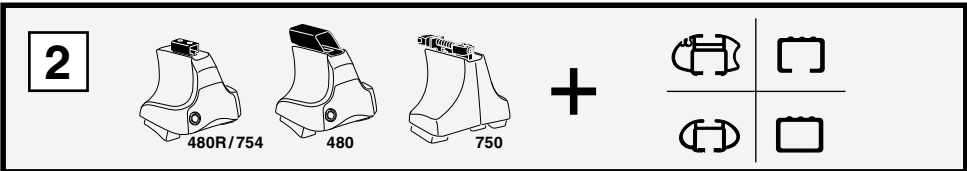
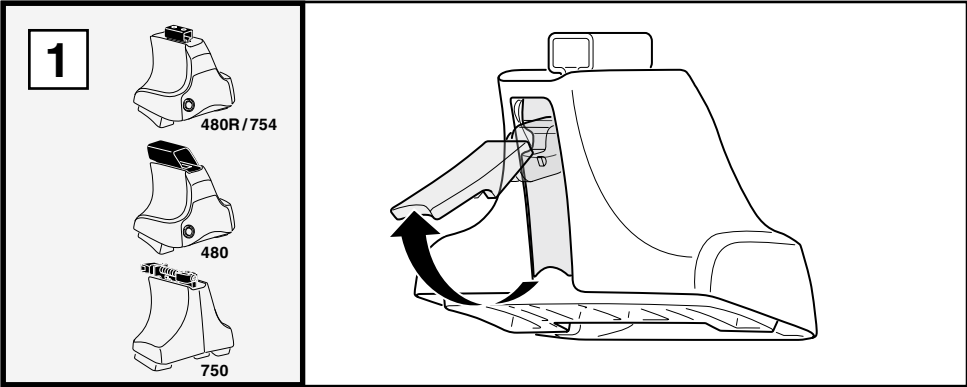

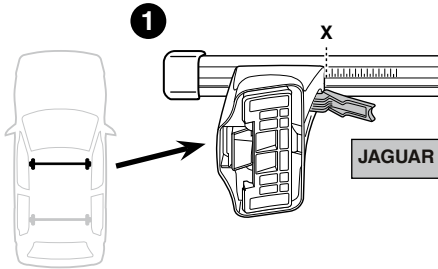
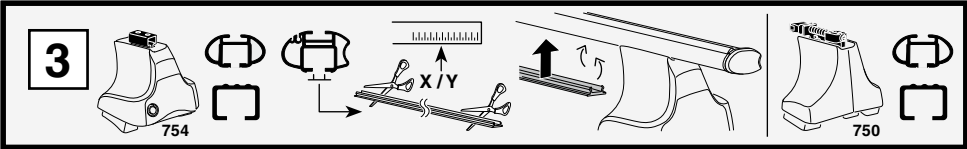

	X
JAGUAR XF, 4-dr Sedan, 08- / *09-	39,5

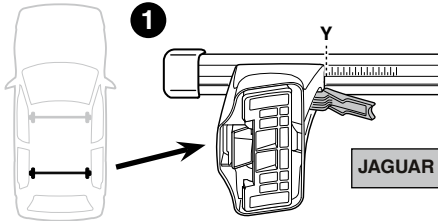
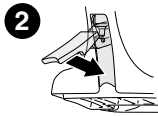

	Y
JAGUAR XF, 4-dr Sedan, 08- / *09-	40

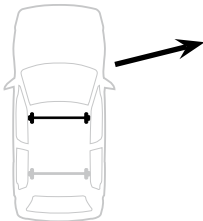
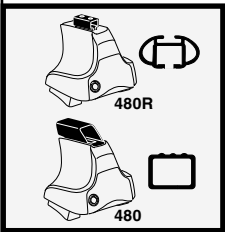
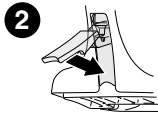

	X inch	X mm
JAGUAR XF, 4-dr Sedan, 08- / *09-	41 1/8"	1046 mm

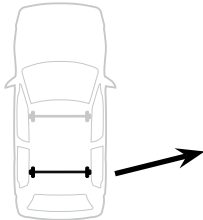
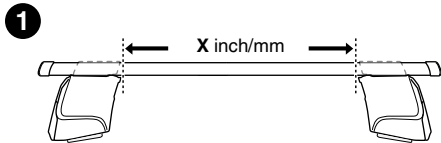

	Y inch	Y mm
JAGUAR XF, 4-dr Sedan, 08- / *09-	41 3/8"	1051 mm



4

JAGUAR XF, 4-dr Sedan, 08- / *09-

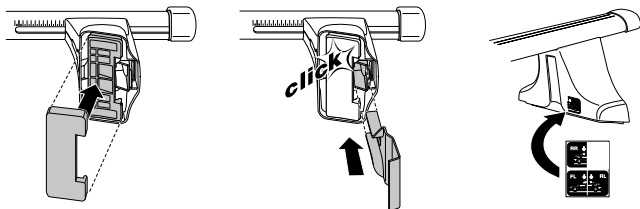
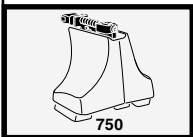
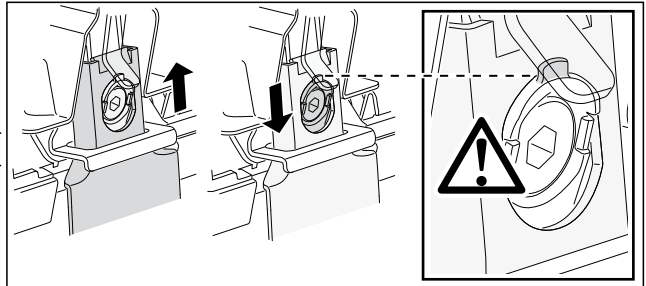
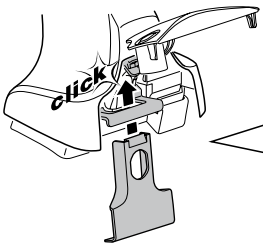
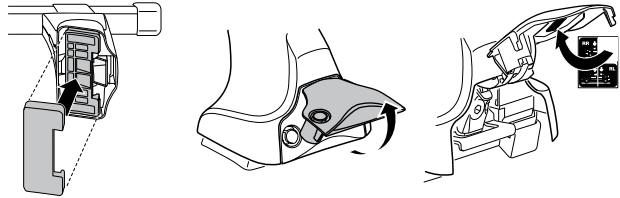
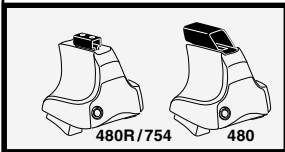
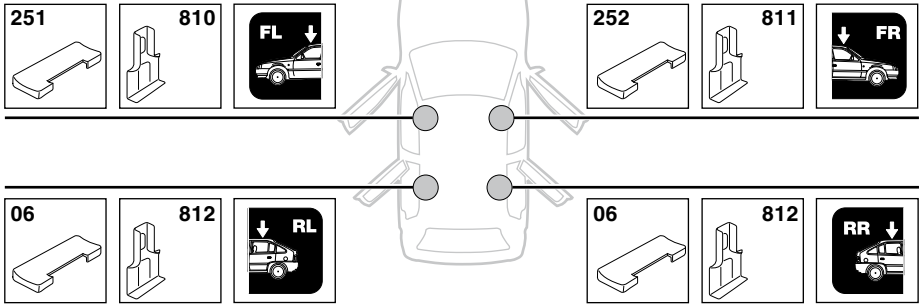

5

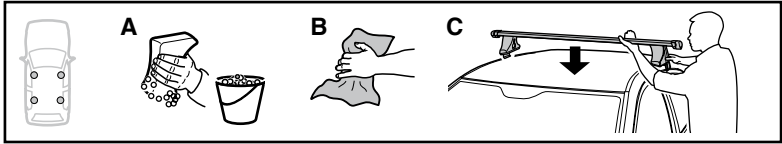

	X mm	Y mm	X inch	Y inch
JAGUAR XF, 4-dr Sedan, 08- / *09-	200 mm	650 mm	7 ⁷ / ₈ "	25 ⁵ / ₈ "

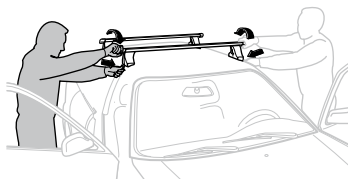
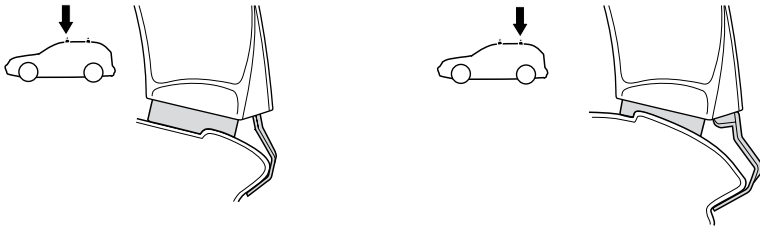
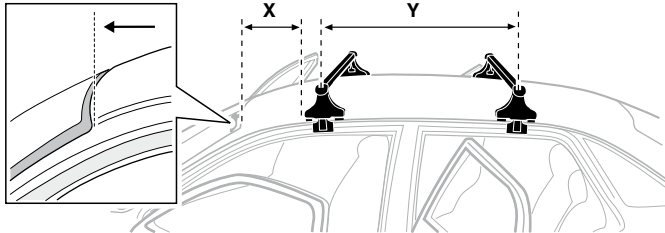

GB/US Tighten alternately

D Die Schrauben abwechselnd anziehen

F Serrer alternativement chaque côté

NL Afwisselend aan de linker- en de rechterkant aandraaien

I Alternare il serraggio delle viti

E Apertar alternativamente

PT Aperte alternadamente

S Dra åt växelvis

FIN Kierrä vuorotellen

EST Pinguldage vaheldumisi

LAT Pievelciēt pamišus

LIT Užsukinėkite pakaitomis

PL Śruby dokręcaj naprzemiennie

RU Затягивайте попеременно

CZ Pokręťta bagażníka dokręcaj dokręcaj naprzemiennie.

SK Doťahujte striedavo

SLO Privijajte izmenično.

HR Naizmjenično zategnite

HU Egymástól függetlenül szorítandó

GR Σφιγγετε εναλλάξ

TR Dönüşümlü sıkın

中文 交替拧紧

한국어 번갈아 가며 조이십시오.

日本語 交互に締め付けてください。

ไทย ชันโนแบบสลับ

6



480R/754



480

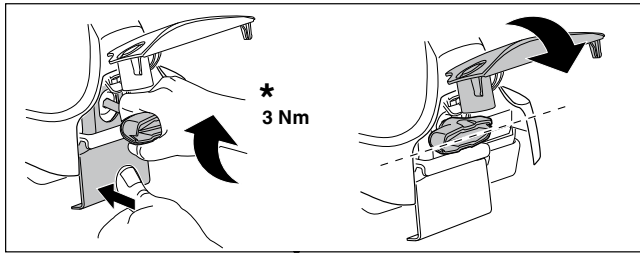
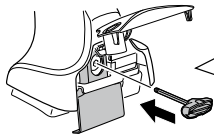

*
3 Nm

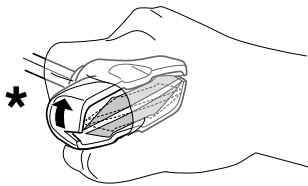

*

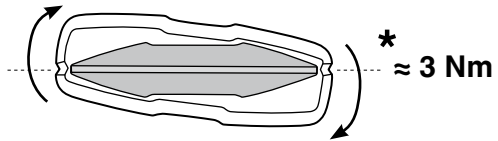

*
≈ 3 Nm

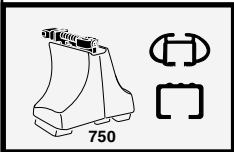
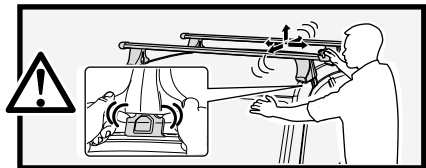

750

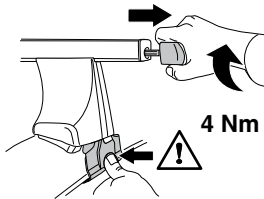

4 Nm

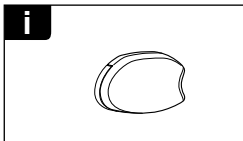
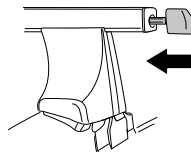

i

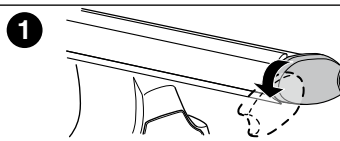

1

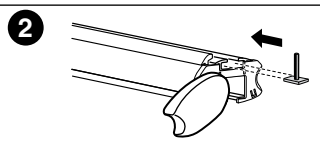

2

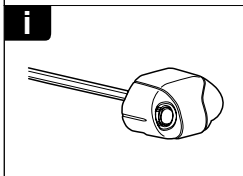

i

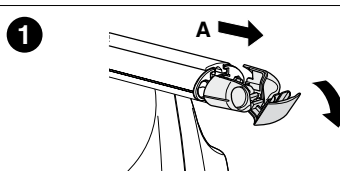

1

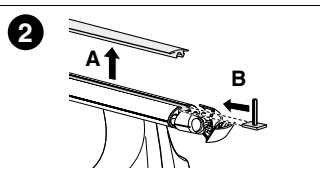

2

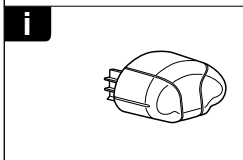

i

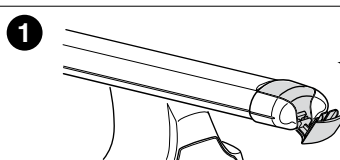

1

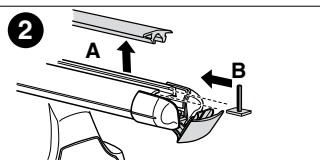

2

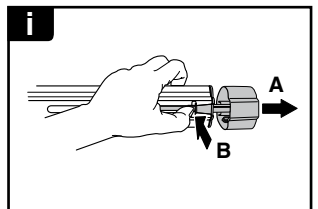
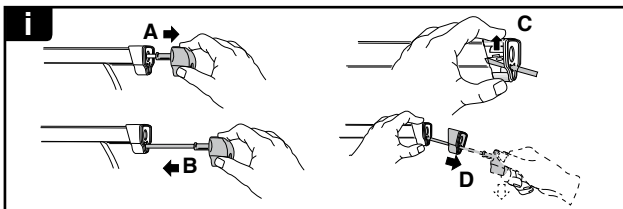
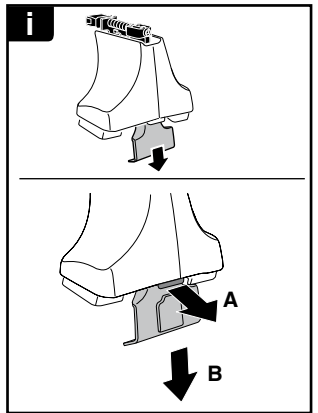
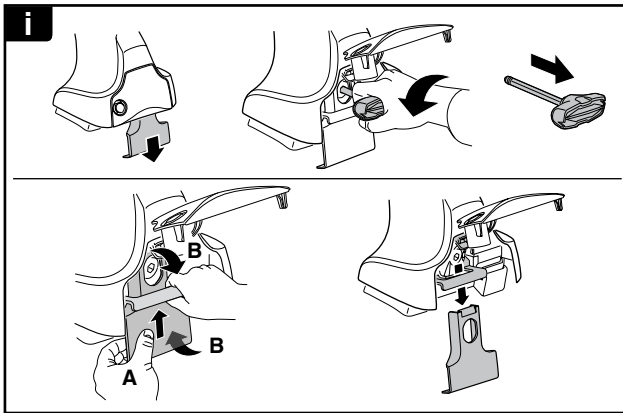
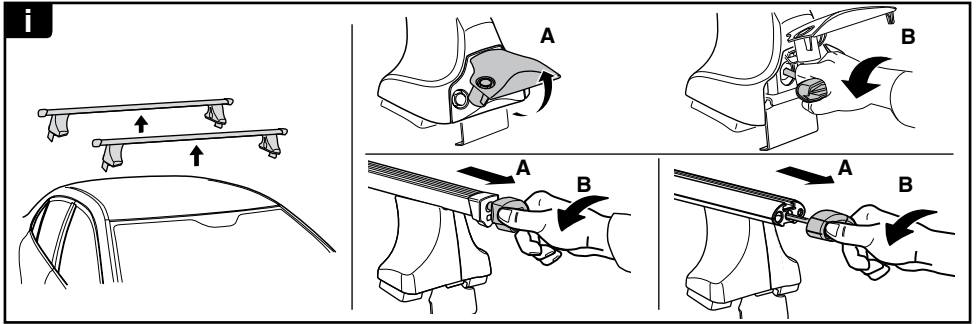

THULE
SWEDEN
**ONE
KEY
SYSTEM**

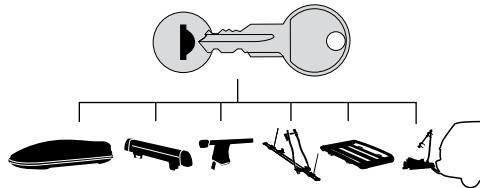

		(x4)
		(x6)
		(x8)
NA		(x10)
EUR		(x12)
ASIA		(x12)

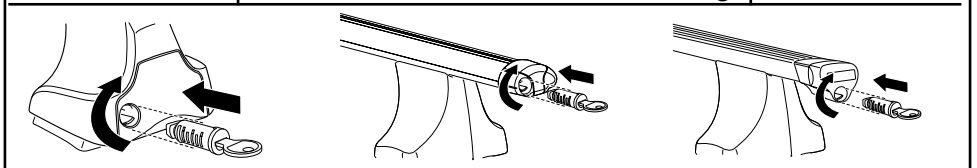

ww ▶ Thule Sweden AB, Box 69, 330 33 Hillerstorp, SWEDEN
NA ▶ Thule Inc., 42 Silvermine Road, Seymour, Connecticut 06483, USA

info@thule.com
customer.service@thule.com

www.thule.com