

Kit 1524

KIA Soul, 5-dr Hatchback, 08- / *10-

*North America

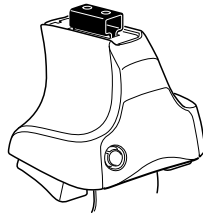

754 Rapid System
480R Rapid Traverse (North America)

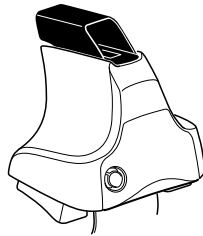

480 Traverse (North America)

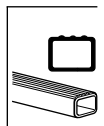

754 Rapid System (North America)

480 Traverse (North America)

(North America)

1



2



754 Rapid System
480R Rapid Traverse
(North America)

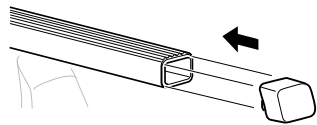
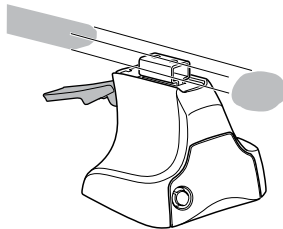

x4

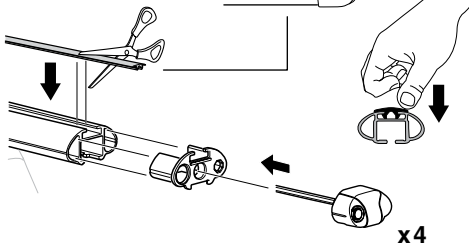
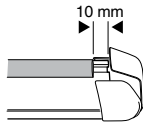
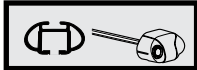

x4

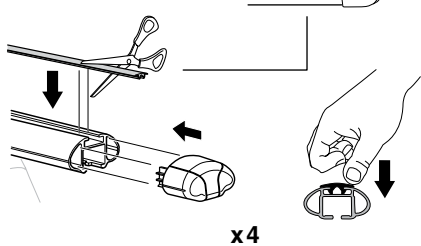
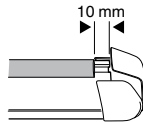

x4



480 Traverse
(North America)

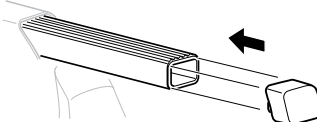
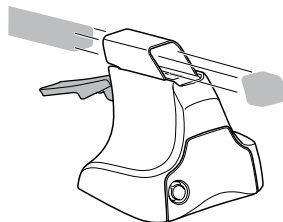

x4

3



754 Rapid System



	X
KIA Soul, 5-dr Hatchback, 08- / *10-	38

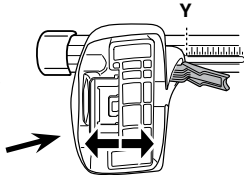

	Y
KIA Soul, 5-dr Hatchback, 08- / *10-	36,5

3



480R Rapid Traverse



480 Traverse

(North America)

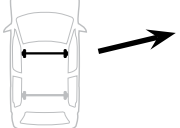

	X inch	X mm
KIA Soul, 5-dr Hatchback, 08- / *10-	40 1/2"	1031 mm

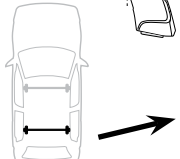
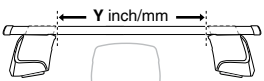

	Y inch	Y mm
KIA Soul, 5-dr Hatchback, 08- / *10-	40"	1016 mm

4

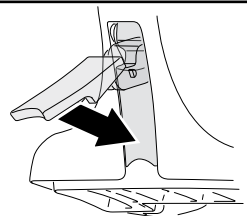

5

KIA Soul, 5-dr Hatchback, 08- / *10-

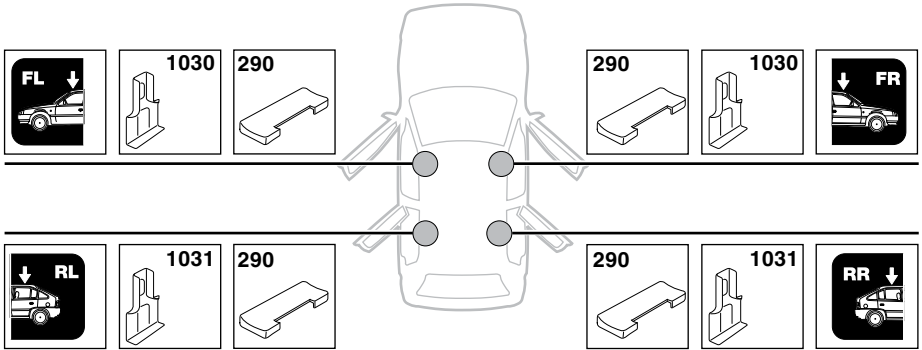

6

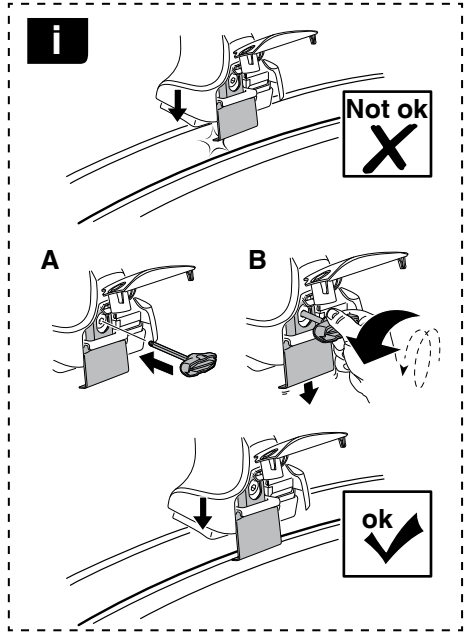
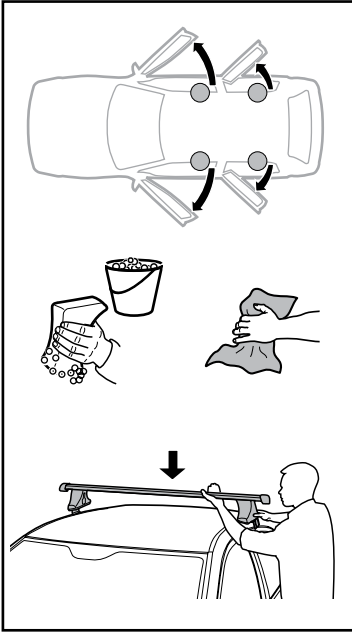

KIA Soul, 5-dr Hatchback, 08- / *10-

X mm	Y mm	X inch	Y inch
265 mm	760 mm	10 1/2"	30"

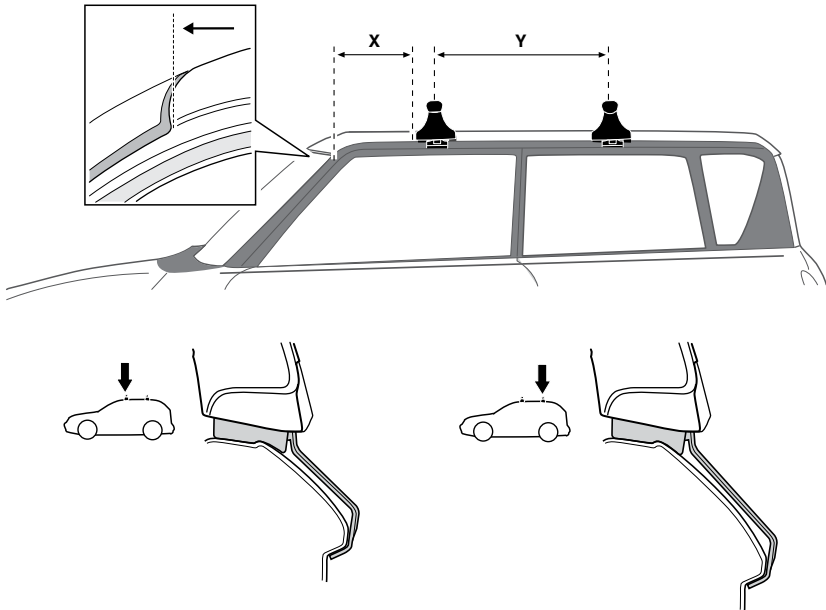

7



GB/US	Tighten alternately
D	Die Schrauben abwechselnd anziehen
F	Serrer alternativement chaque côté
NL	Afwisselend aan de linker- en de rechterkant aandraaien
I	Alternare il serraggio delle viti
E	Apretar alternativamente
PT	Aperte alternadamente
S	Dra åt växelvis
FIN	Kierrä vuorotellen
EST	Pinguldage vaheldumisi
LAT	Pielveiciet pamišus
LIT	Užsukinėkite pakaitomis
PL	Śruby dokręcaj naprzemiennie
RU	Затягивайте попеременно

CZ	Pokręřta bagažníka dokręřcaj dokręřcaj naprzemiennie.
SK	Dofahajte striedavo
SLO	Privijajte izmenično.
HR	Naizmjenočno zategnite
HU	Egymástól függetlenül szorítandó
GR	Σφιγίγες ενολάξ
TR	Dönüşümlü sıkın

中文 交替拧紧

한국어 번갈아 가며 조이십시오.

日本語 交互に締め付けてください。

ไทย ชันในแบบสลับ

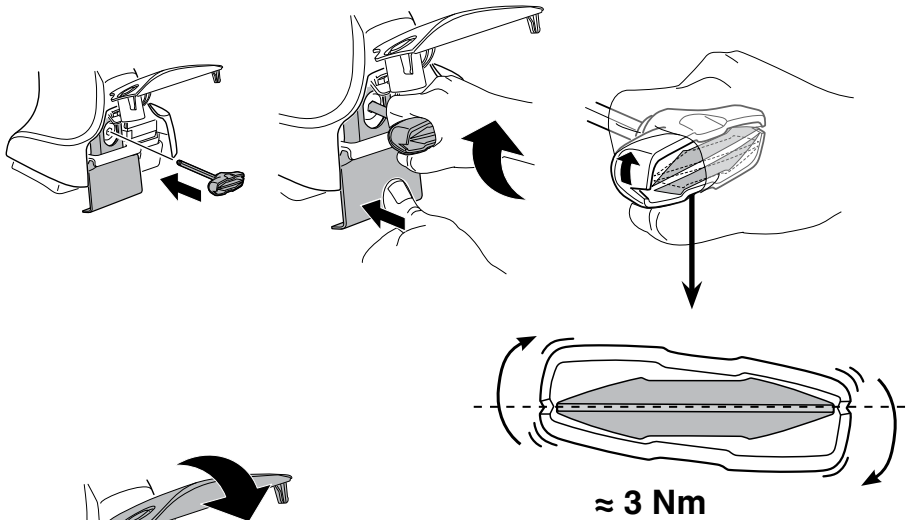

8



x1
17 mm

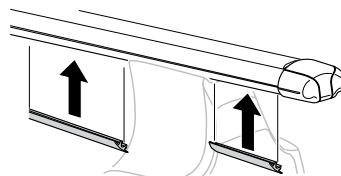
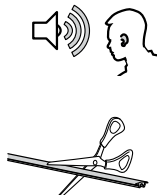

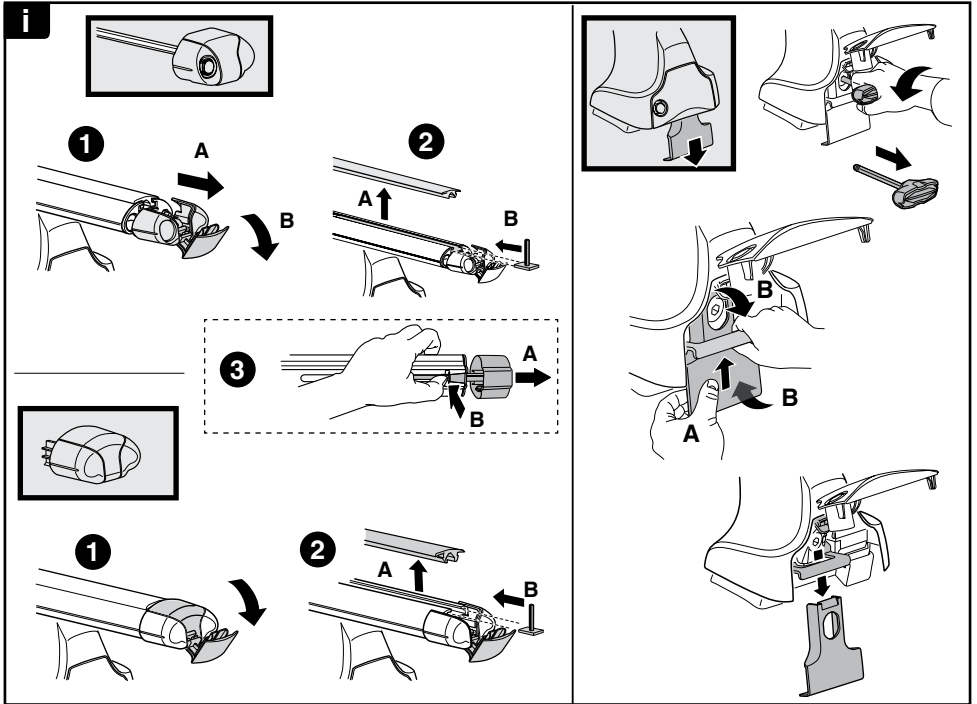
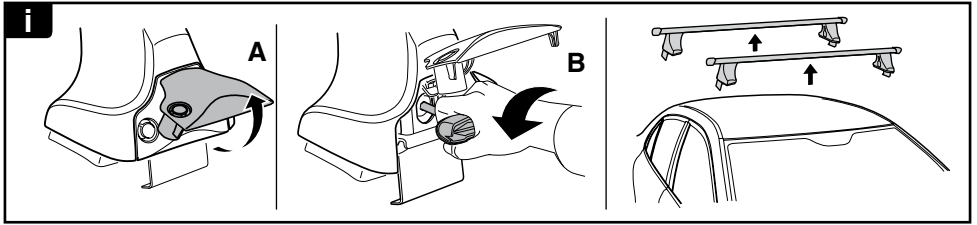

THULE
SWEDEN

**ONE
KEY
SYSTEM**

544 (x4)

596 (x6)

588 (x8)

NA 510 (x10)

EUR 452 (x12)

ASIA