

# Kit 1502

TOYOTA Avensis, 4-dr Sedan, 09-

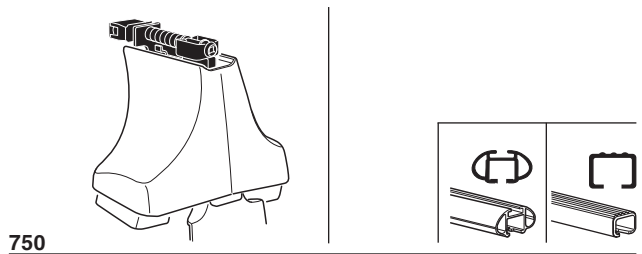

**Kit**

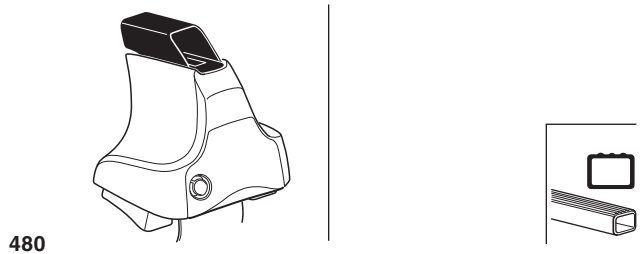
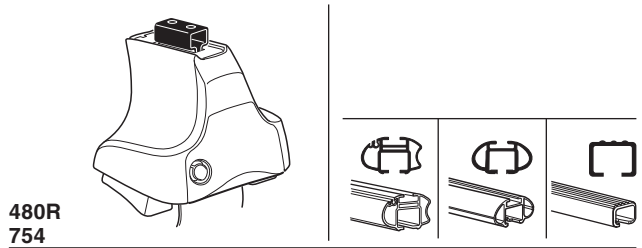
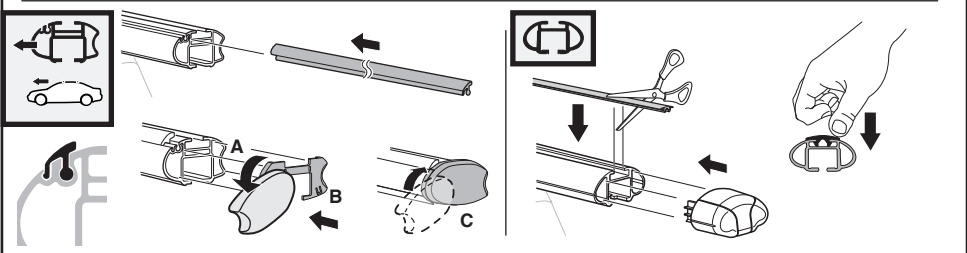
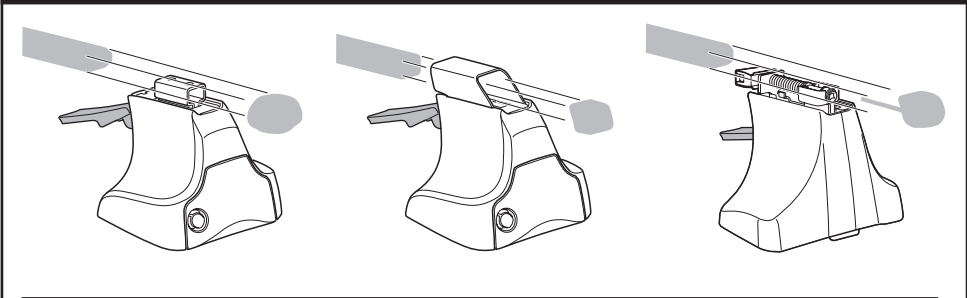

3

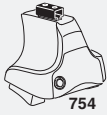

754

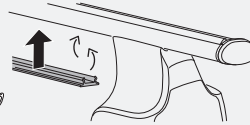
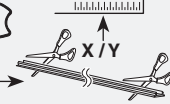

750

1

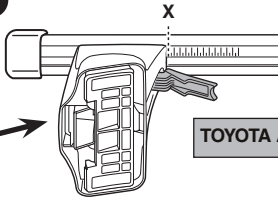
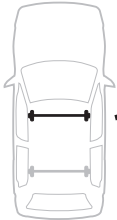

2

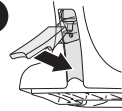

TOYOTA Avensis, 4-dr Sedan, 09-

X
38,5

1

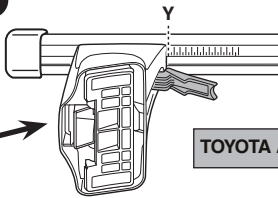
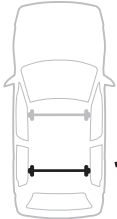

2

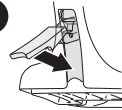

TOYOTA Avensis, 4-dr Sedan, 09-

Y
36,5



480R



480

1

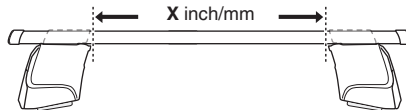

2

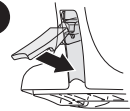

TOYOTA Avensis, 4-dr Sedan, 09-

X inch	X mm
40 3/4"	1036 mm

1

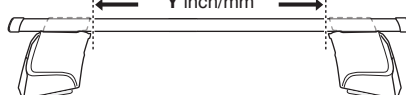

2

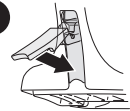

TOYOTA Avensis, 4-dr Sedan, 09-

Y inch	Y mm
40"	1016 mm

# 4

TOYOTA Avensis, 4-dr Sedan, 09-

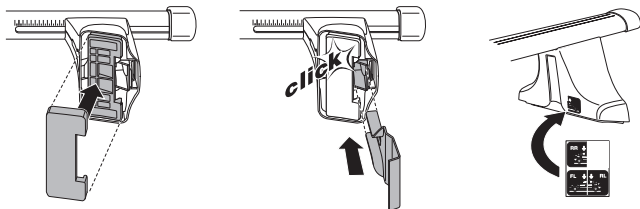
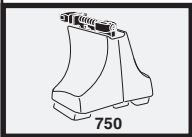
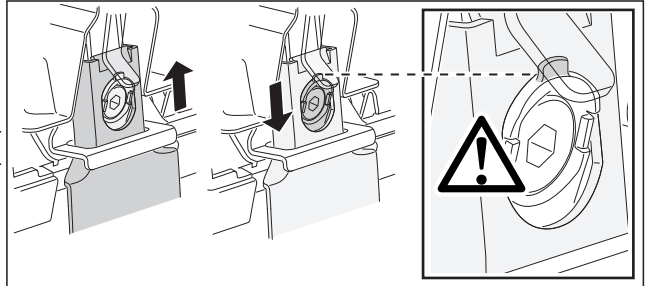
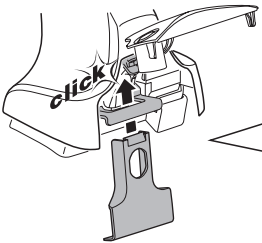
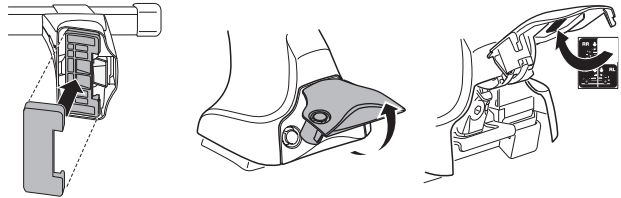
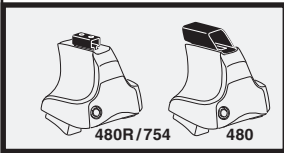
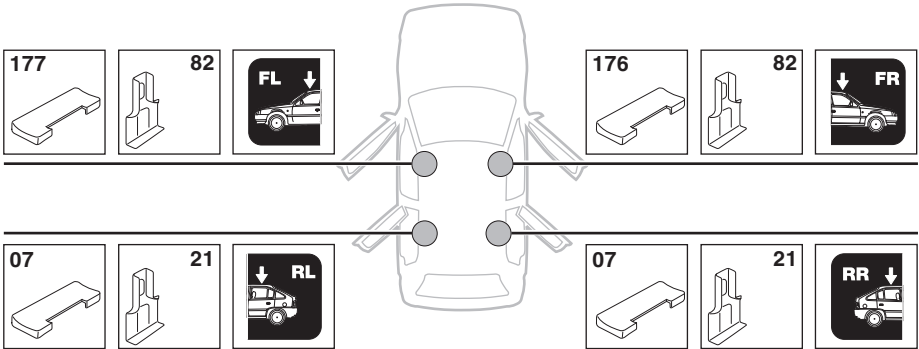

5

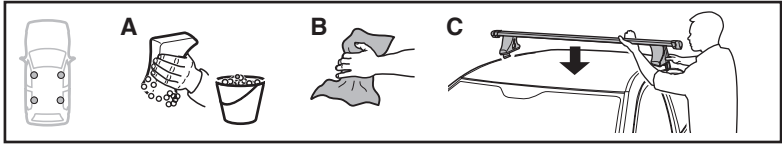

	X mm	Y mm	X inch	Y inch
TOYOTA Avensis, 4-dr Sedan, 09-	260 mm	600 mm	10 1/4"	23 5/8"

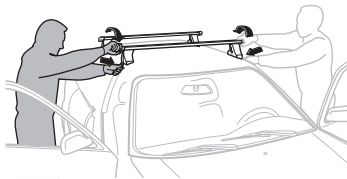
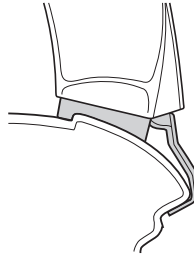
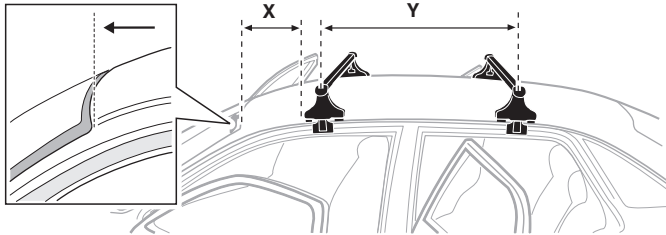

**GB/US** Tighten alternately

**D** Die Schrauben abwechselnd anziehen

**F** Serrer alternativement chaque côté

**NL** Afwisselend aan de linker- en de rechterkant aandraaien

**I** Alternare il serraggio delle viti

**E** Apretar alternativamente

**PT** Aperte alternadamente

**S** Dra åt växelvis

**FIN** Kierrä vuorotellen

**EST** Pinguldage vaheldumisi

**LAT** Pielieciet pamišus

**LIT** Užsukinėkite pakaitomis

**PL** Śruby dokręcaj naprzemiennie

**RU** Затягивайте попеременно

**CZ** Pokręťta bagażníka dokręcaj dokręcaj naprzemiennie.

**SK** Doťahujte striedavo

**SLO** Privijajte izmenično.

**HR** Naizmjenično zategnite

**HU** Egymástól függetlenül szorítandó

**GR** Σφιγγετε εναλλάξ

**TR** Dönüşümlü sıkın

**中文** 交替拧紧

**한국어** 번갈아 가며 조이십시오.

**日本語** 交互に締め付けてください。

**ไทย** ชันโนแบบสลับ

6



480R/754



480

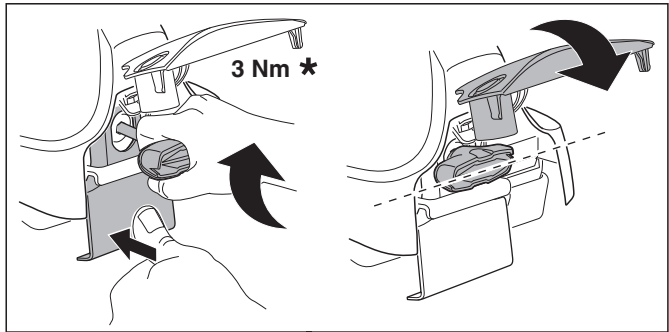
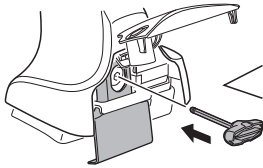

3 Nm \*

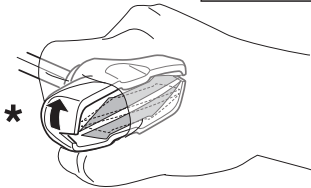

\*

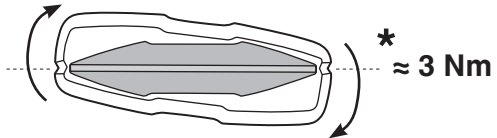

\* ≈ 3 Nm



750

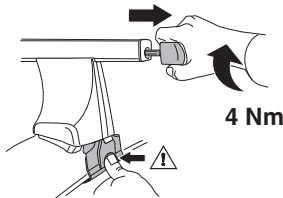

4 Nm

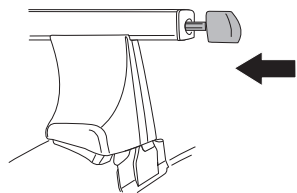

i



1



2

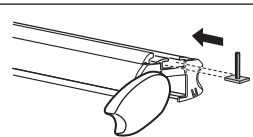

i

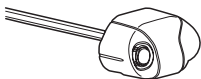

1

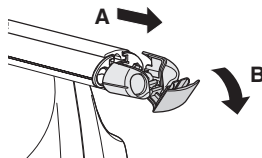

2

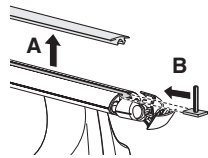

i

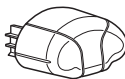

1

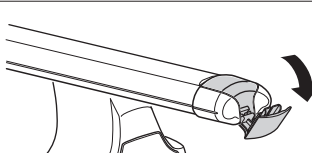

2

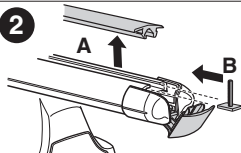

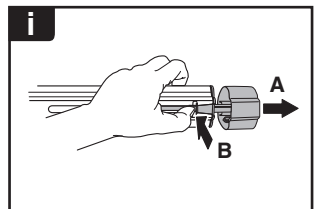
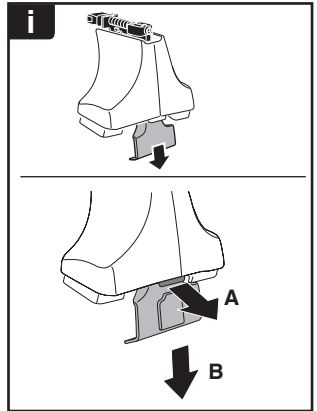
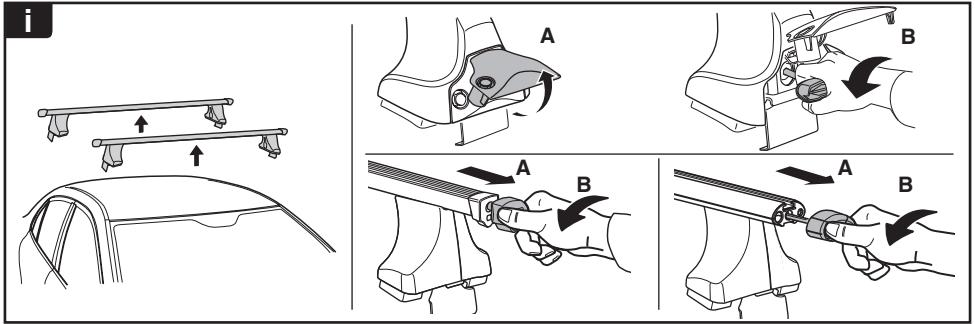

**THULE**  
SWEDEN  
**ONE  
KEY  
SYSTEM**



- 544 (x4)
- 596 (x6)
- 588 (x8)
- NA 510 (x10)
- EUR 452 (x12)
- ASIA

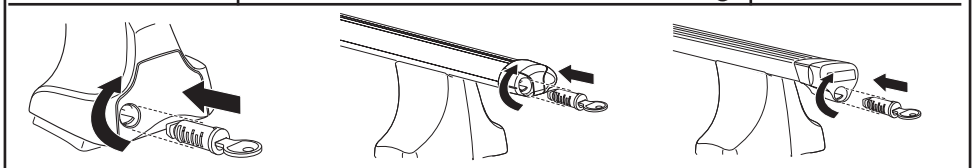

WW ▶ Thule Sweden AB, Box 69, 330 33 Hillerstorp, SWEDEN  
NA ▶ Thule Inc., 42 Silvermine Road, Seymour, Connecticut 06483, USA

info@thule.com  
customer.service@thule.com

www.thule.com