

Kit 1501

VOLKSWAGEN Passat CC, 4-dr Coupé, 08–
VOLKSWAGEN Passat CC, 4-dr Coupé, *09–

*North America

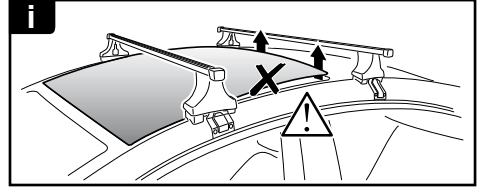

480R
754

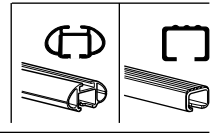
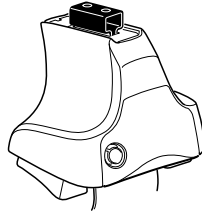

480

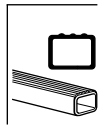
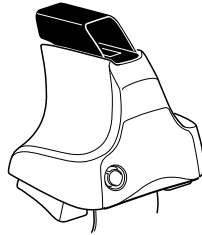

750

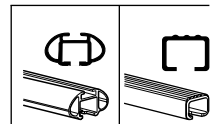
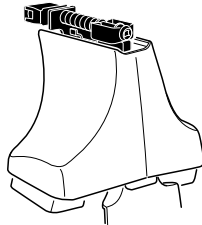

THULE[®]
SWEDEN

ISO 11154-E

Kit

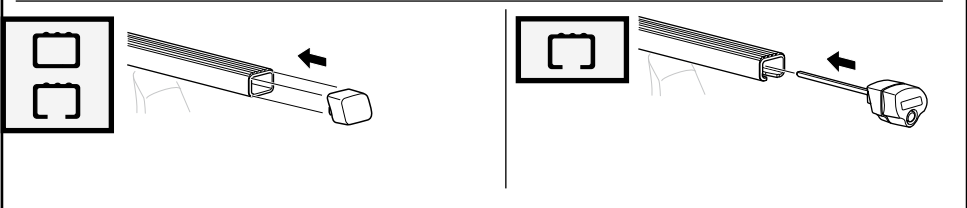
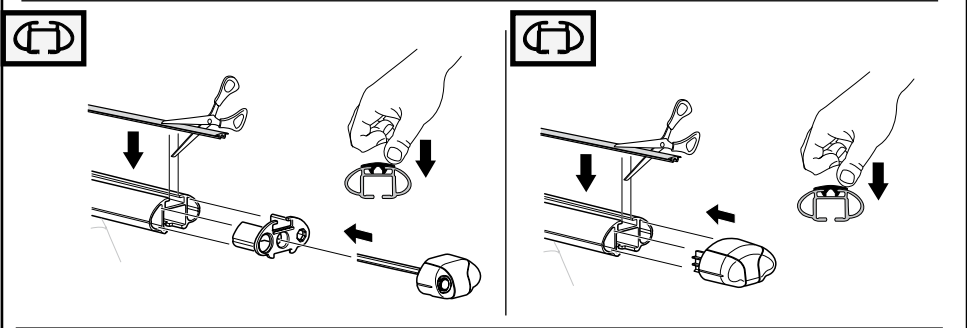
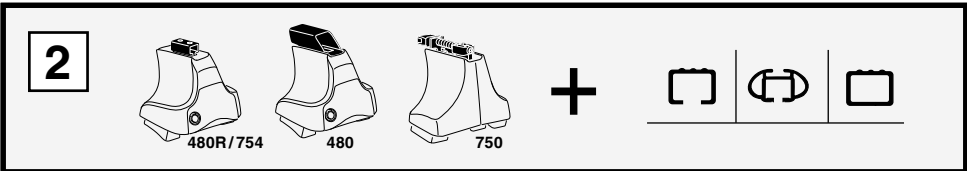

3

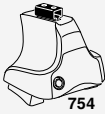

754



750



1

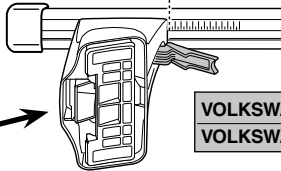
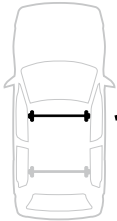

2

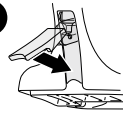

	X
VOLKSWAGEN Passat CC, 4-dr Coupé, 08-	42
VOLKSWAGEN Passat CC, 4-dr Coupé, *09-	42

1

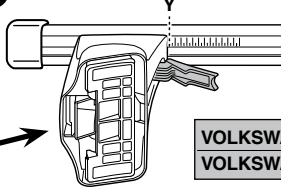

2

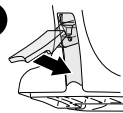

	Y
VOLKSWAGEN Passat CC, 4-dr Coupé, 08-	38
VOLKSWAGEN Passat CC, 4-dr Coupé, *09-	38



480R



480

1

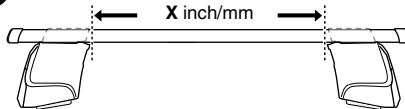

2

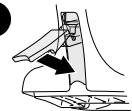

	X inch	X mm
VOLKSWAGEN Passat CC, 4-dr Coupé, 08-	42 1/8"	1071 mm
VOLKSWAGEN Passat CC, 4-dr Coupé, *09-	42 1/8"	1071 mm

1

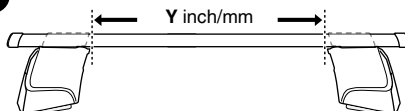

2

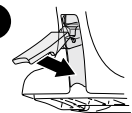

	Y inch	Y mm
VOLKSWAGEN Passat CC, 4-dr Coupé, 08-	40 5/8"	1031 mm
VOLKSWAGEN Passat CC, 4-dr Coupé, *09-	40 5/8"	1031 mm

4

VOLKSWAGEN Passat CC, 4-dr Coupé, 08-
VOLKSWAGEN Passat CC, 4-dr Coupé, *09-

302



983



FL



303



983



FR



206



982



RL



204



982



RR



480R/754



480

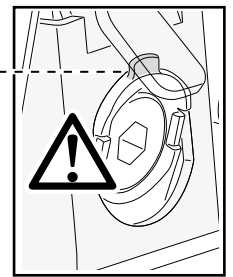
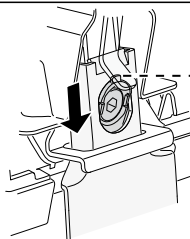
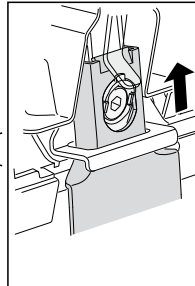
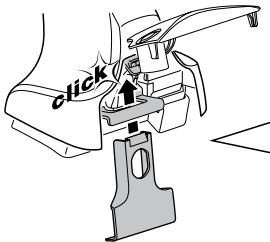
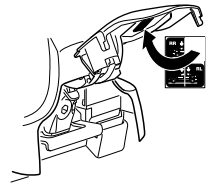
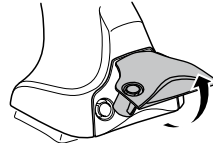
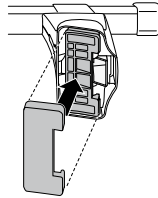

750

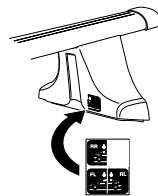
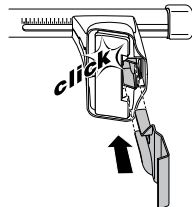
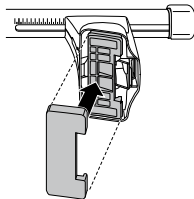

5

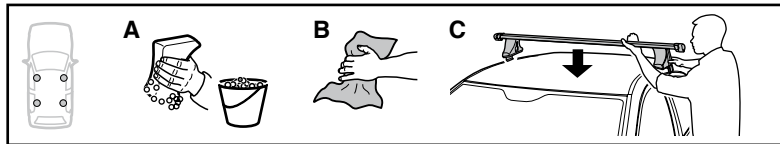

	X mm	Y mm	X inch	Y inch
VOLKSWAGEN Passat CC, 4-dr Coupé, 08–	170 mm	730 mm	6 3/4"	28 3/4"
VOLKSWAGEN Passat CC, 4-dr Coupé, *09–	170 mm	730 mm	6 3/4"	28 3/4"

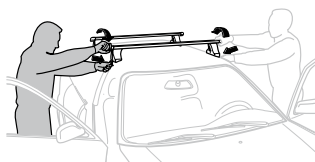
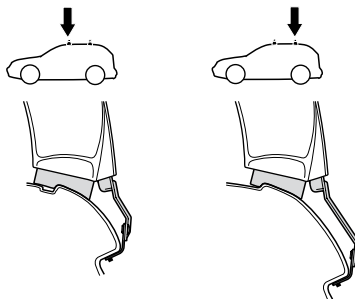
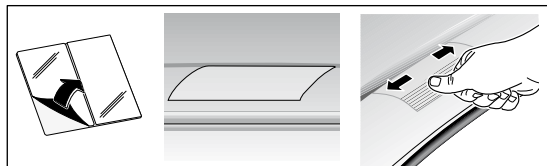
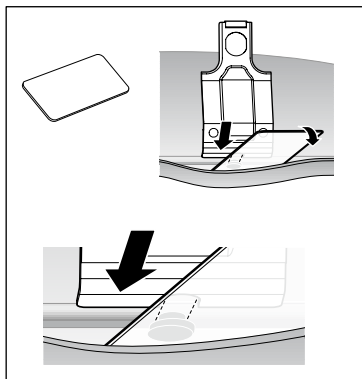
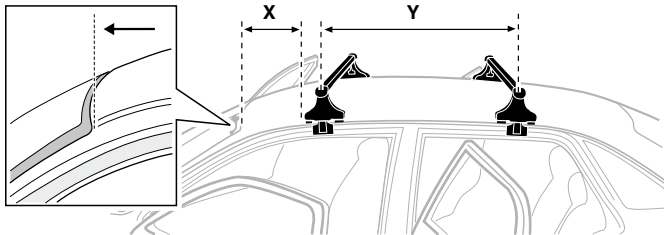

GB/US Tighten alternately
D Die Schrauben abwechselnd anziehen
F Serrer alternativement chaque côté
NL Afwisselend aan de linker- en de rechterkant aandraaien
I Alternare il serraggio delle viti
E Serrare alternativamente
PT Aperte alternadamente
S Dra åt växelvis
FIN Kierrä vuorotellen
EST Pinguldage vaheldumisi
LAT Pievelciēt pamišus
LIT Užsukinėkite pakaitomis
PL Śruby dokręcaj naprzemiennie
RU Затягивайте попеременно

CZ Pokrétla багаžníka dokręcaj dokręcaj naprzemiennie.
SK Dofahujte striedavo.
SLO Privijajte izmenično.
HR Naizmjenično zategnite.
HU Egymástól függetlenül szorítandó.
GR Σφιγγετε εναλλάξ.
TR Dönüşümlü sıkın.
中文 交替拧紧
한국어 번갈아 가며 조이십시오.
日本語 交互に締め付けてください。
ไทย ชั้้นในแบบสลับ

6

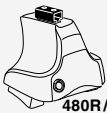

480R/754



480

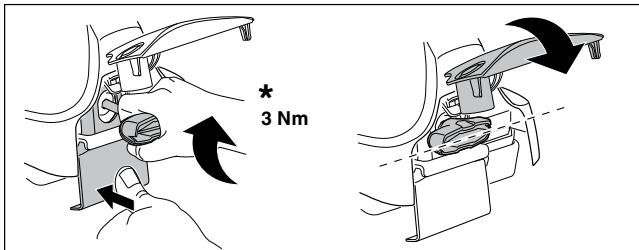
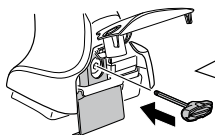

*
3 Nm

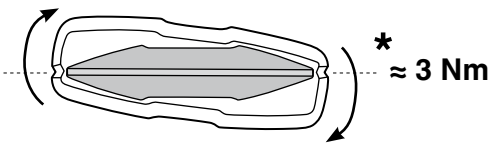
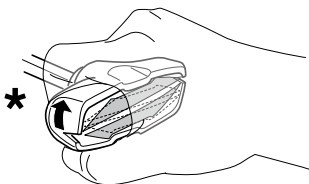

*
≈ 3 Nm

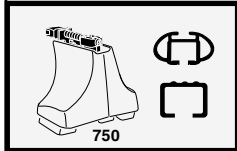
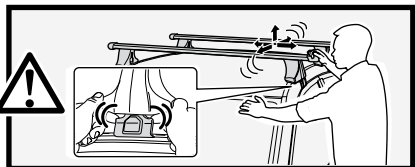

750

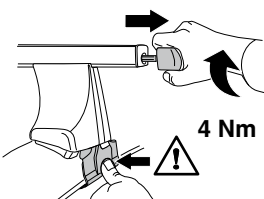

4 Nm

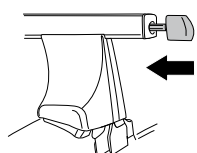

7

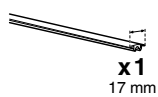

x1
17 mm

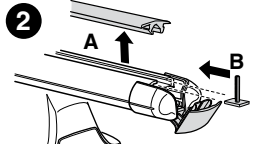
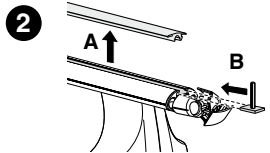
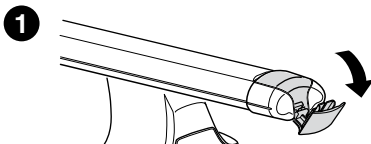
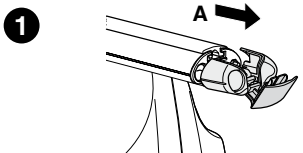
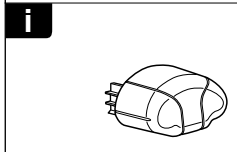
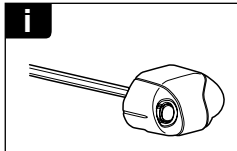
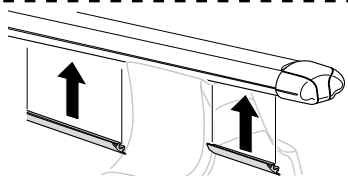

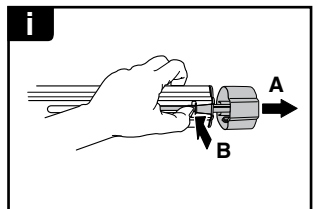
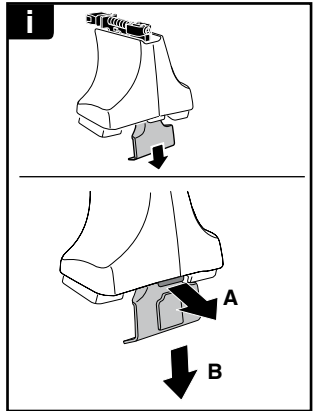

THULE
SWEDEN
**ONE
KEY
SYSTEM**



		544	(x4)
		596	(x6)
		588	(x8)
NA		510	(x10)
EUR		452	(x12)
ASIA			



WW ▶ Thule Sweden AB, Box 69, 330 33 Hillerstorp, SWEDEN
NA ▶ Thule Inc., 42 Silvermine Road, Seymour, Connecticut 06483, USA

info@thule.com
customer.service@thule.com

www.thule.com