

# Kit 1492

ACURA TSX, 4-dr Sedan, 09–  
HONDA Accord, 4-dr Sedan, 08–

480R  
754

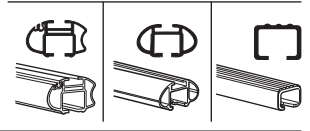
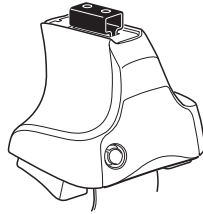

480

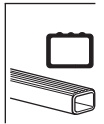
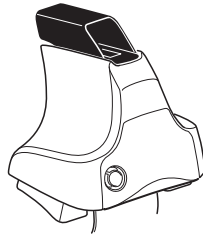

750

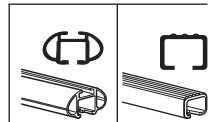
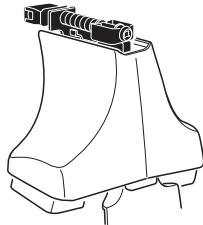

**Kit**

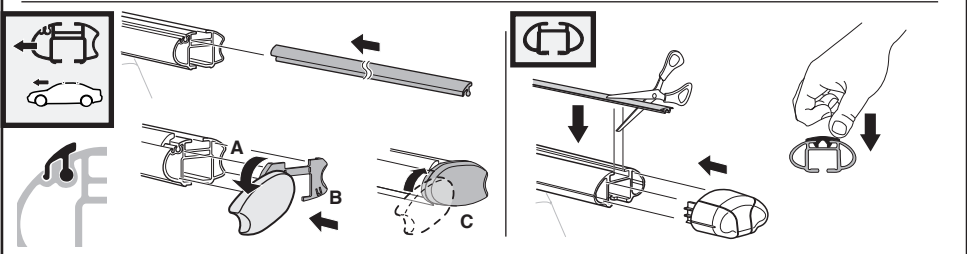
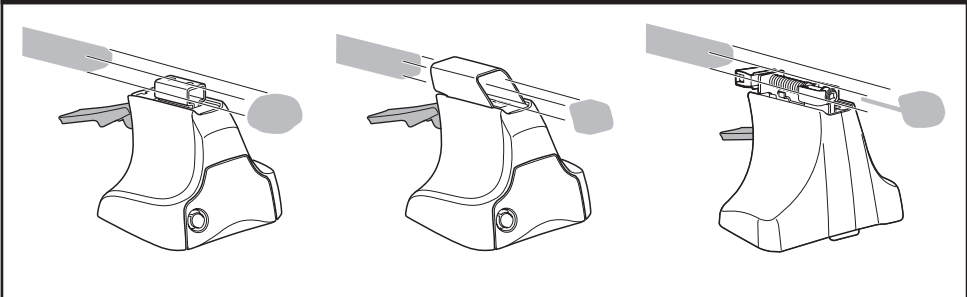

**3**

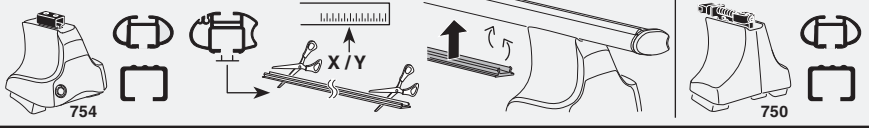

**1**

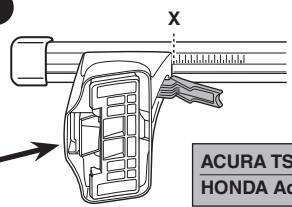
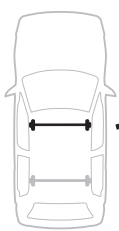

	X
ACURA TSX, 4-dr Sedan, 09–	43
HONDA Accord, 4-dr Sedan, 08–	42,5

**2**



**1**

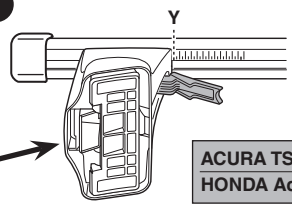
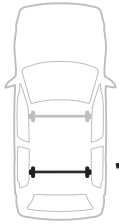

	Y
ACURA TSX, 4-dr Sedan, 09–	37.5
HONDA Accord, 4-dr Sedan, 08–	37

**2**

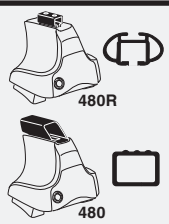
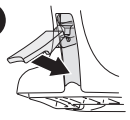

**1**

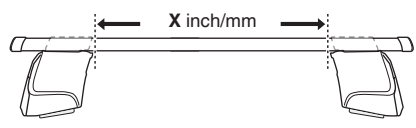
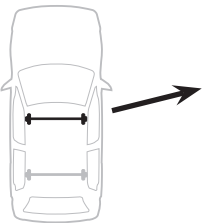

	X inch	X mm
ACURA TSX, 4-dr Sedan, 09–	42 1/2"	1081 mm
HONDA Accord, 4-dr Sedan, 08–	42 3/8"	1076 mm

**2**

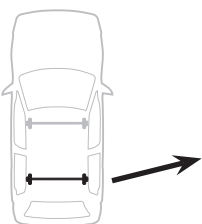

**1**

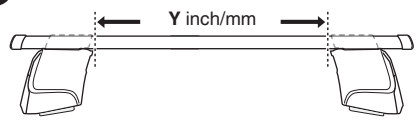

	Y inch	Y mm
ACURA TSX, 4-dr Sedan, 09–	40 1/2"	1026 mm
HONDA Accord, 4-dr Sedan, 08–	40 1/4"	1021 mm

**2**



# 4

ACURA TSX, 4-dr Sedan, 09–  
 HONDA Accord, 4-dr Sedan, 08–

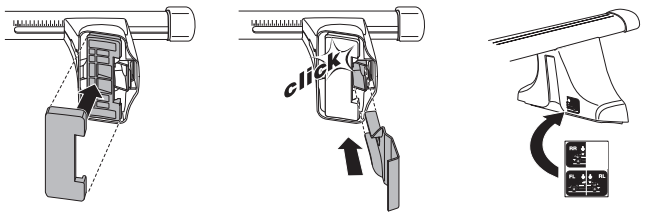
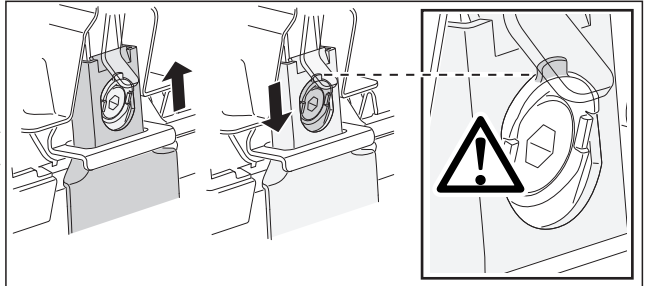
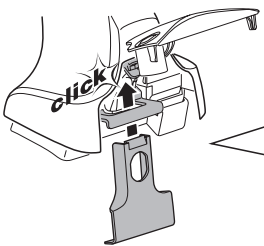
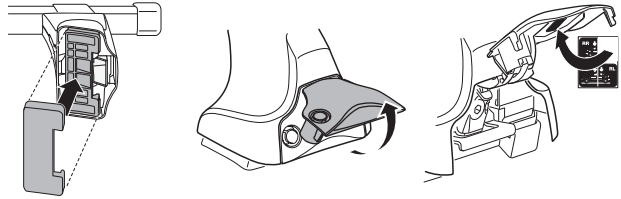
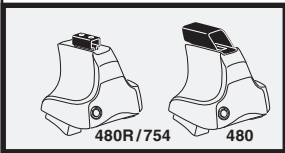
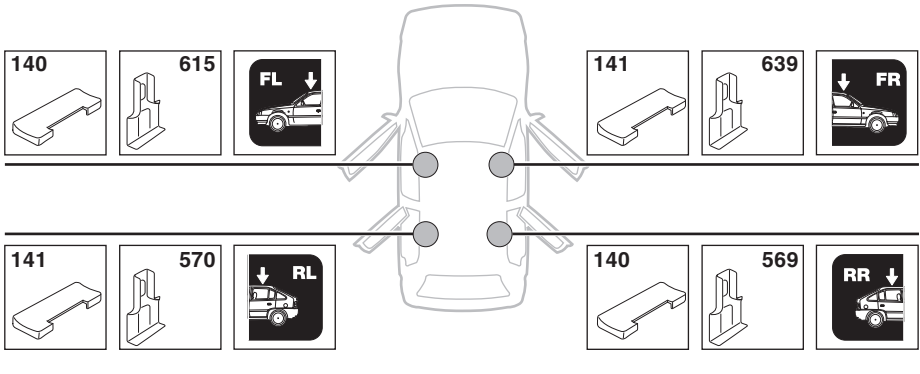

5

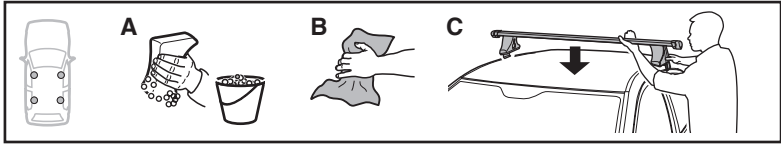

	X mm	Y mm	X inch	Y inch
ACURA TSX, 4-dr Sedan, 09–	250 mm	650 mm	9 7/8"	25 5/8"
HONDA Accord, 4-dr Sedan, 08–	250 mm	650 mm	9 7/8"	25 5/8"

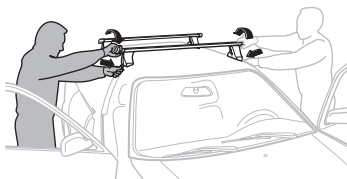
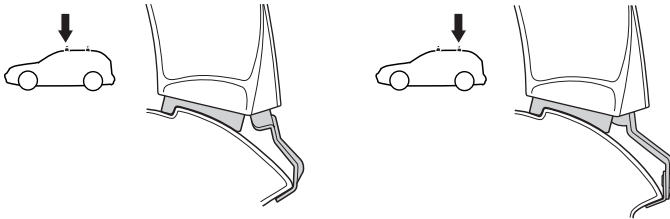
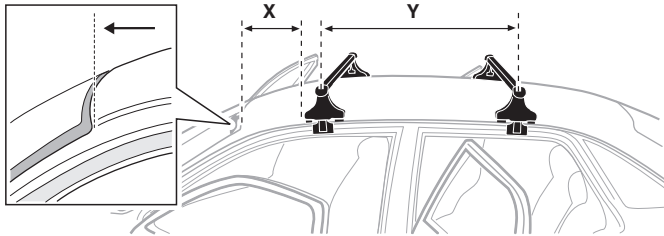

**GB/US** Tighten alternately

**D** Die Schrauben abwechselnd anziehen

**F** Serrer alternativement chaque côté

**NL** Afwisselend aan de linker- en de rechterkant aandraaien

**I** Alternare il serraggio delle viti

**E** Serrare alternativamente

**PT** Aperte alternadamente

**S** Dra åt växelvis

**FIN** Kierrä vuorotellen

**EST** Pinguldage vaheldumisi

**LAT** Pielvecliet pamišus

**LIT** Užsukinėkite pakaitomis

**PL** Śruby dokręcaj naprzemiennie

**RU** Затягивайте попеременно

**CZ** Pokręťta bagazníka dokręcaj dokręcaj naprzemiennie.

**SK** Doťahujte striedavo

**SLO** Privijajte izmenično.

**HR** Naizmjenično zategnite

**HU** Egymástól függetlenül szorítandó

**GR** Σφίγγετε εναλλάξ

**TR** Dönüşümlü sıkın

**中文** 交替拧紧

**한국어** 번갈아 가며 조이십시오.

**日本語** 交互に締め付けてください。

**ไทย** ชันโนแบบสลับ

6



480R/754



480

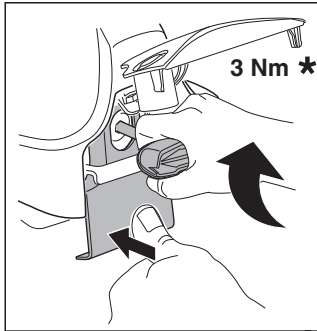
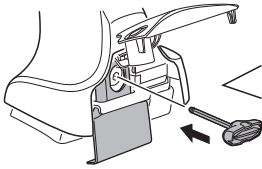

3 Nm \*

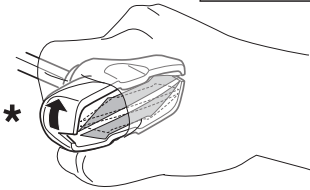
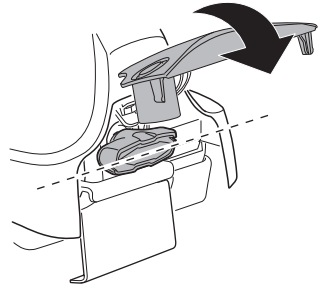

\*

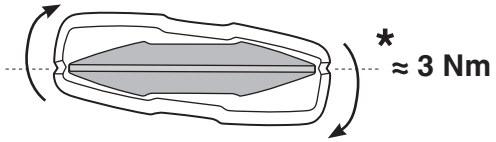

\* ≈ 3 Nm



750

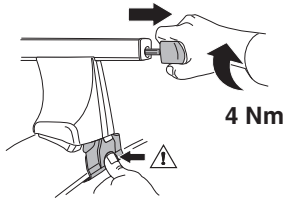

4 Nm

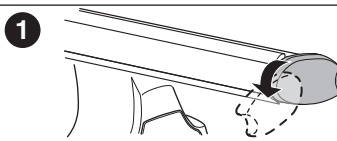
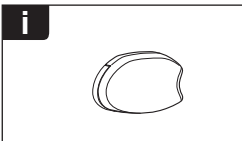
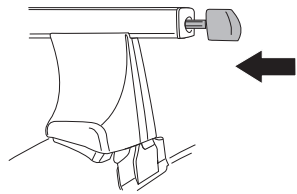

1

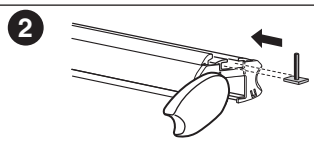

2

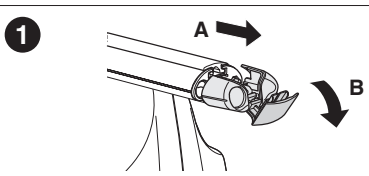
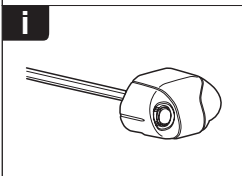

1

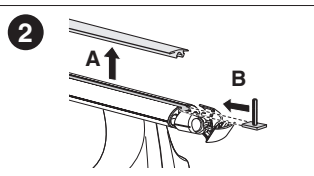

2

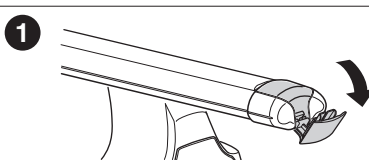
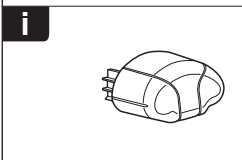

1

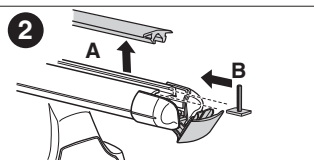

2

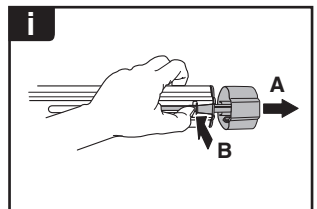
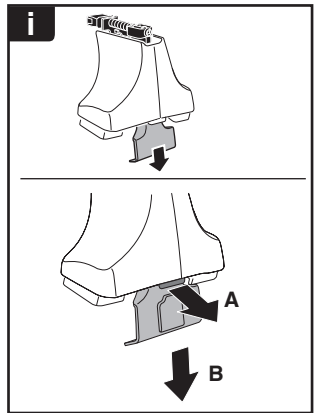
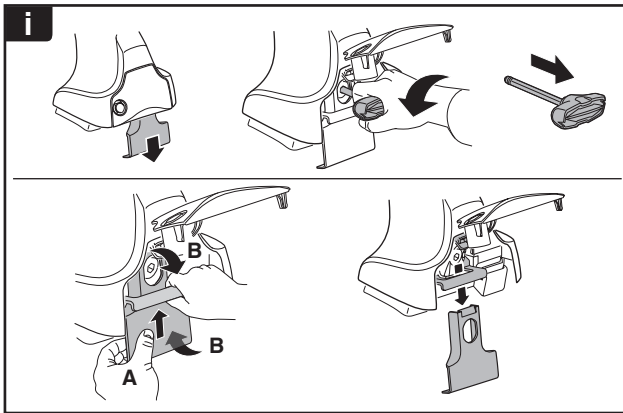
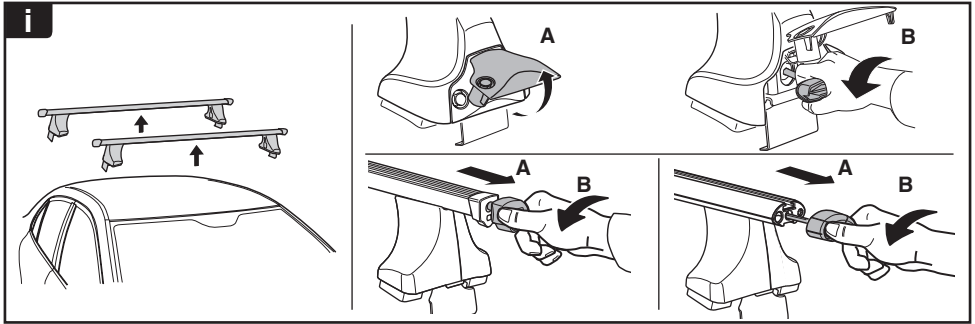

**THULE**  
SWEDEN  
**ONE  
KEY  
SYSTEM**



- 544 (x4)
- 596 (x6)
- 588 (x8)
- NA 510 (x10)
- EUR 452 (x12)
- ASIA

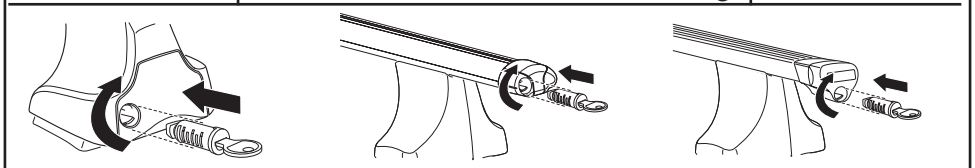

WW ▶ Thule Sweden AB, Box 69, 330 33 Hillerstorp, SWEDEN  
NA ▶ Thule Inc., 42 Silvermine Road, Seymour, Connecticut 06483, USA

info@thule.com  
customer.service@thule.com

www.thule.com