

Kit 1454

NISSAN Dualis, 5-dr SUV, 07–
NISSAN Qashqai, 5-dr SUV, 07–

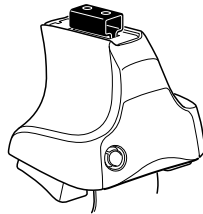

754 Rapid System
480R Rapid Traverse (North America)

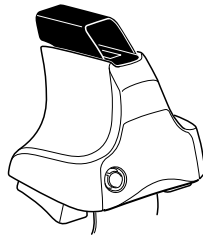
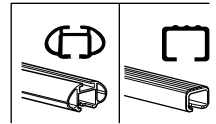

480 Traverse (North America)

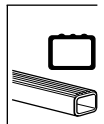

1



2



754 Rapid System
480R Rapid Traverse
(North America)

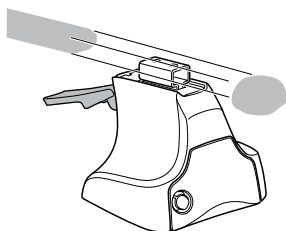

x4

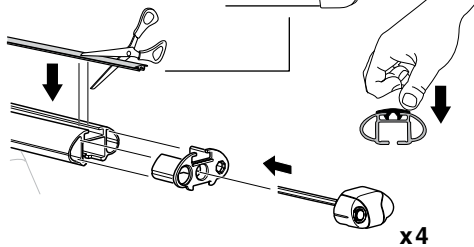
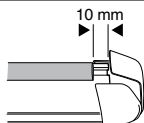
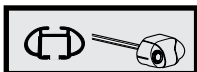

x4

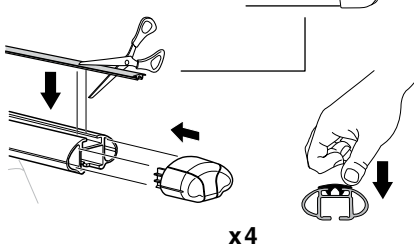
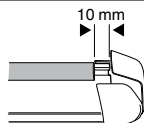
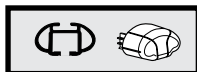

x4



480 Traverse
(North America)

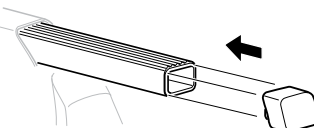
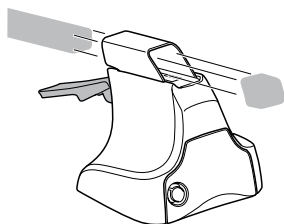

x4

3



754 Rapid System

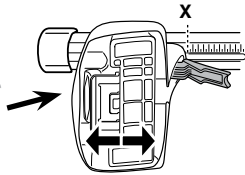

	X
NISSAN Dualis, 5-dr SUV, 07-	43,5
NISSAN Qashqai, 5-dr SUV, 07-	43,5

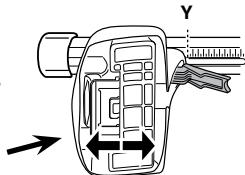

	Y
NISSAN Dualis, 5-dr SUV, 07-	40,5
NISSAN Qashqai, 5-dr SUV, 07-	40,5

3



480R Rapid Traverse



480 Traverse

(North America)

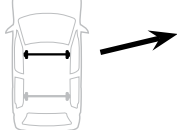

	X inch	X mm
NISSAN Dualis, 5-dr SUV, 07-	42 3/4"	1086 mm
NISSAN Qashqai, 5-dr SUV, 07-	42 3/4"	1086 mm

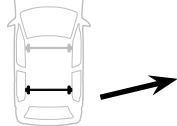

	Y inch	Y mm
NISSAN Dualis, 5-dr SUV, 07-	41 5/8"	1056 mm
NISSAN Qashqai, 5-dr SUV, 07-	41 5/8"	1056 mm

4

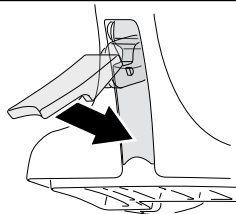

5

NISSAN Dualis, 5-dr SUV, 07-
NISSAN Qashqai, 5-dr SUV, 07-

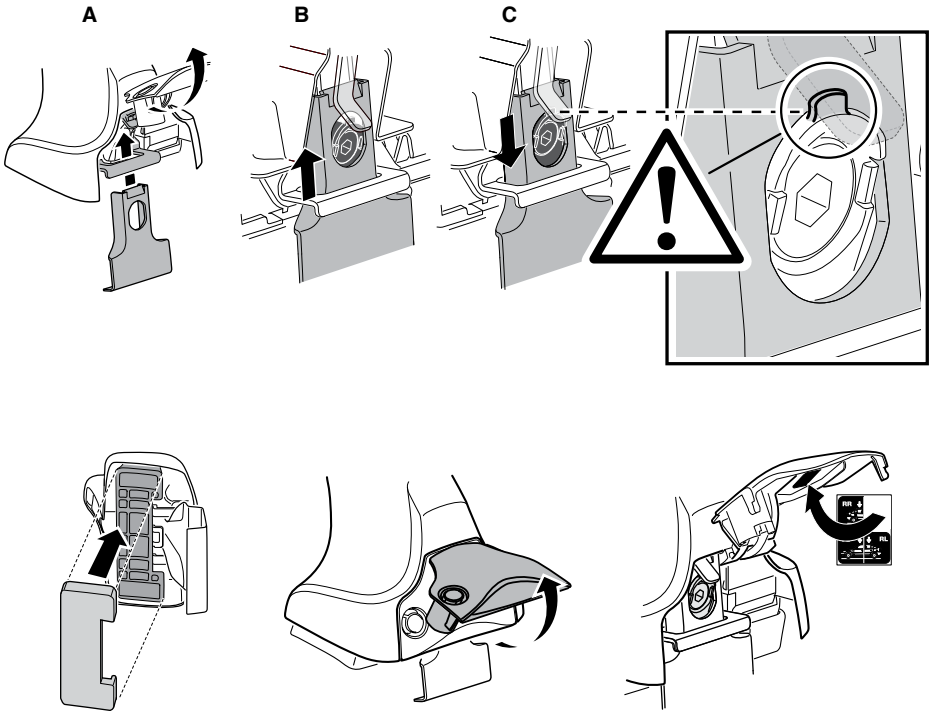
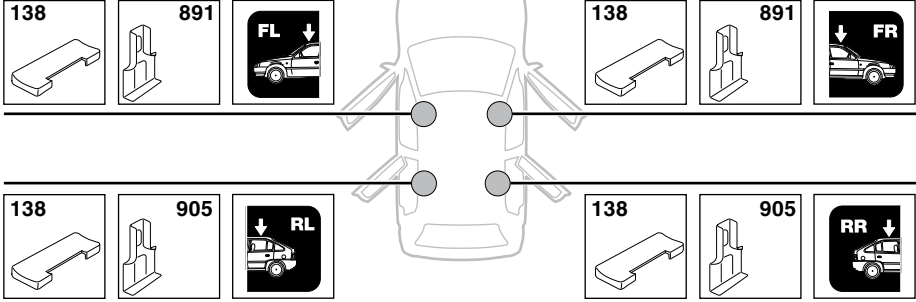

6

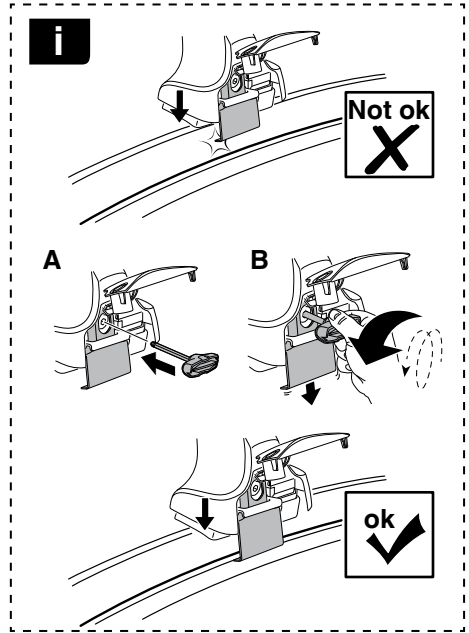
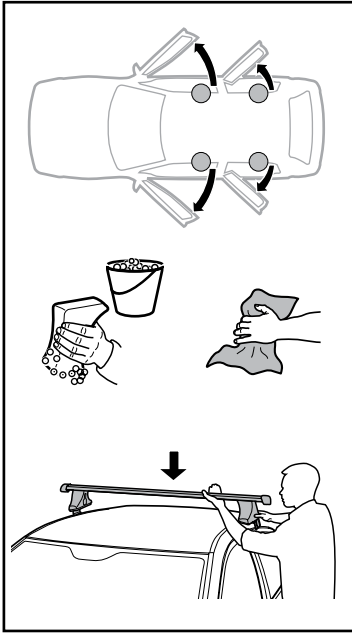

	X mm	Y mm	X inch	Y inch
NISSAN Dualis, 5-dr SUV, 07-	370 mm	770 mm	14 ⁵ / ₈ "	30 ³ / ₈ "
NISSAN Qashqai, 5-dr SUV, 07-	370 mm	770 mm	14 ⁵ / ₈ "	30 ³ / ₈ "

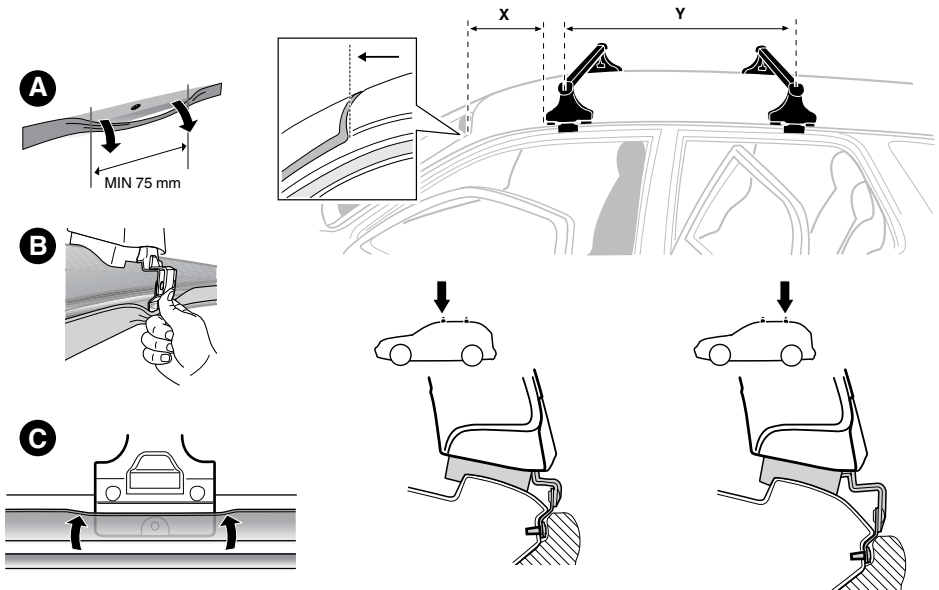

7

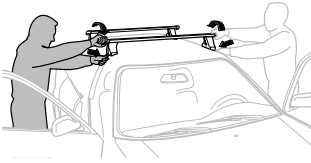

GB/US Tighten alternately
D Die Schrauben abwechselnd anziehen
F Serrer alternativement chaque côté
NL Afwisselend aan de linker- en de rechterkant aandraaien
I Alternare il serraggio delle viti
E Apertar alternativamente
PT Aperte alternadamente
S Dra åt växelvis
FIN Kierrä vuorotellen
EST Pinguldage vaheldumisi
LAT Pieļieciet pamišus
LIT Užsukinėkite pakaitomis
PL Śruby dokręcaj naprzemiennie
RU Затягивайте попеременно

CZ Pokręťta bagażnika dokręcaj naprzemiennie.
SK Dofahajte striedavo
SLO Privijajte izmenično.
HR Naizmjerno zategnite
HU Egymástól függetlenül szorítandó
GR Σφιγίγτες εναλλάξ
TR Dönüşümlü sıkın

中文 交替拧紧

한국어 번갈아 가며 조이십시오.

日本語 交互に締め付けてください。

ไทย ชันในแบบสลับ

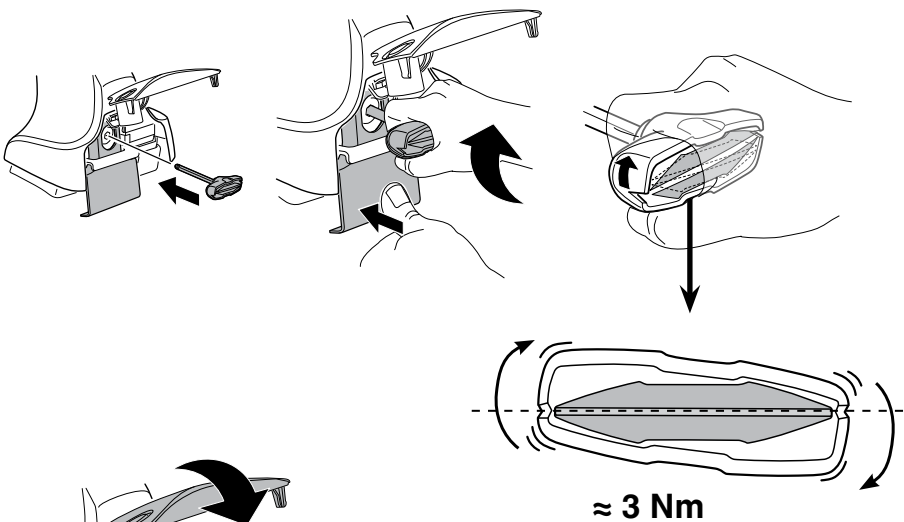

8



x1
17 mm

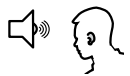
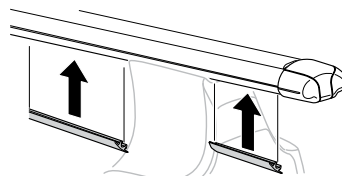
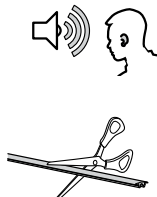

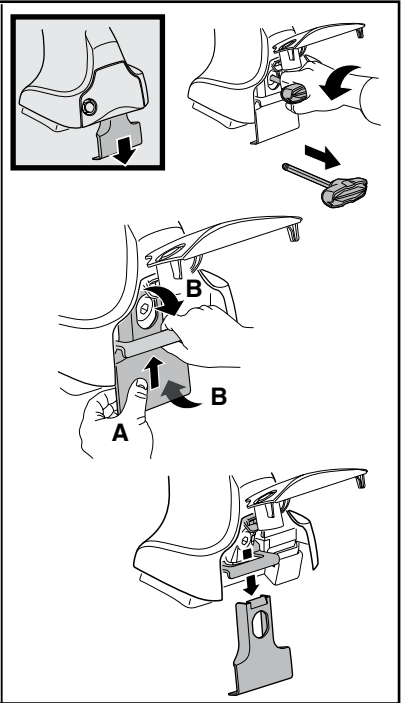
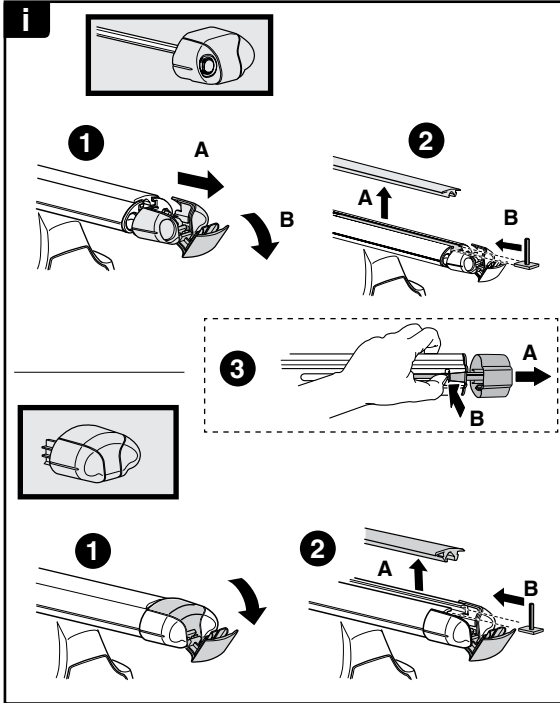

THULE
SWEDEN
**ONE
KEY
SYSTEM**

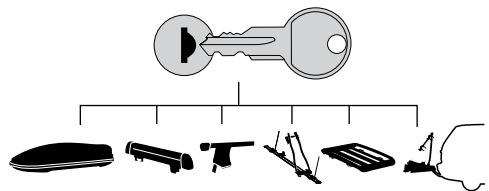

- 544 (x4)
- 596 (x6)
- 588 (x8)
- NA 510 (x10)
- EUR 452 (x12)
- ASIA

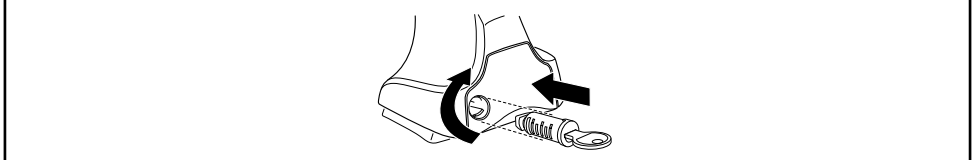

WW ▶ Thule Sweden AB, Box 69, 330 33 Hillerstorp, SWEDEN
NA ▶ Thule Inc., 42 Silvermine Road, Seymour, Connecticut 06483, USA

info@thule.com
customer.service@thule.com

www.thule.com