

Kit 1416

HONDA Civic, 5-dr Hatchback, 06-11*

* without glass roof

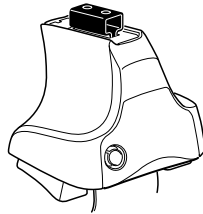

754 Rapid System
480R Rapid Traverse (North America)

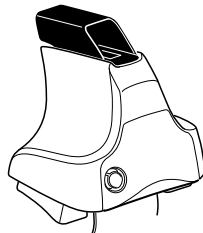
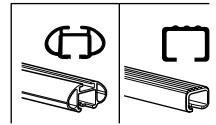

480 Traverse (North America)

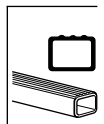

Kit

1

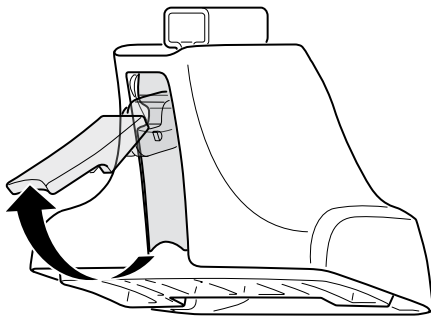

2



754 Rapid System
480R Rapid Traverse
(North America)

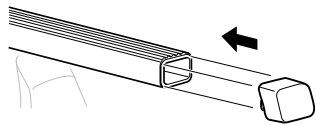
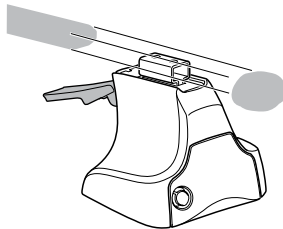

x4

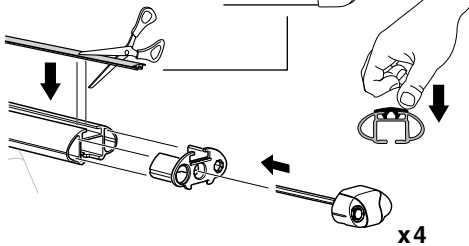
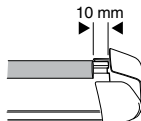
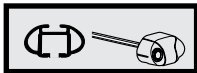

x4

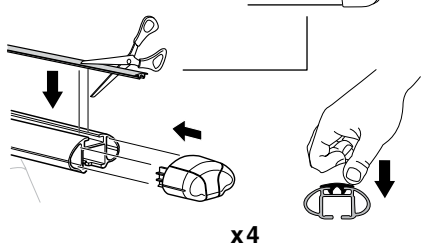
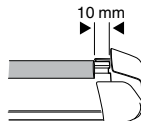
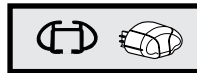

x4



480 Traverse
(North America)

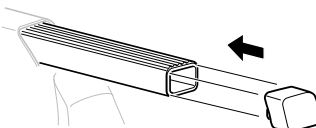
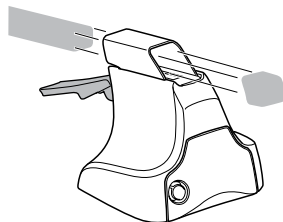

x4

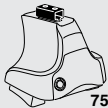
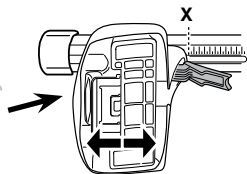
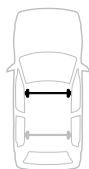
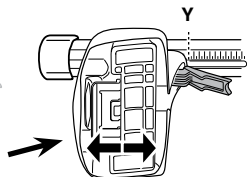
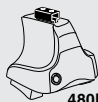
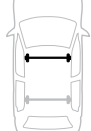
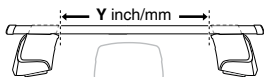
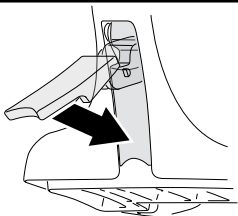
3**754** Rapid System**HONDA Civic, 5-dr Hatchback, 06-11****X****39****HONDA Civic, 5-dr Hatchback, 06-11****Y****27,5****3****480R** Rapid Traverse**480** Traverse**(North America)****HONDA Civic, 5-dr Hatchback, 06-11****X inch****X mm****41"****1041 mm****HONDA Civic, 5-dr Hatchback, 06-11****Y inch****Y mm****36 1/2"****926 mm****4**

5

HONDA Civic, 5-dr Hatchback, 06-11

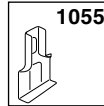
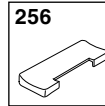
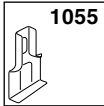
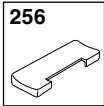
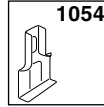
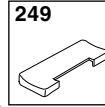
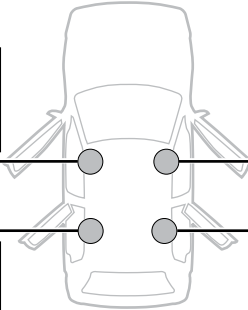
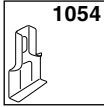
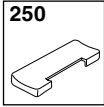

A

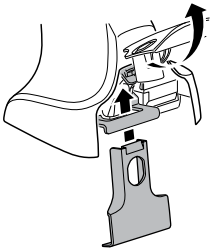

B

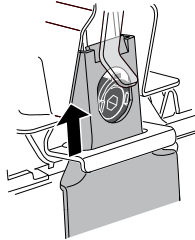

C

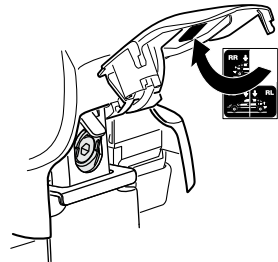
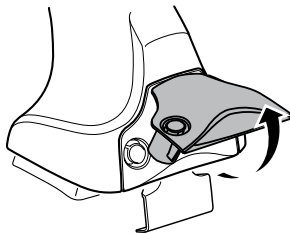
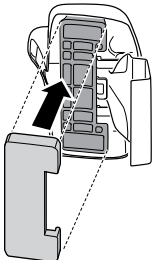
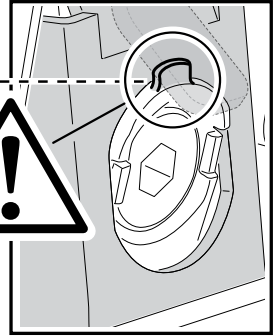
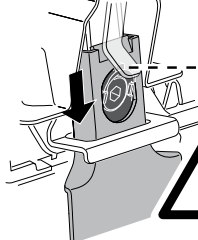

6

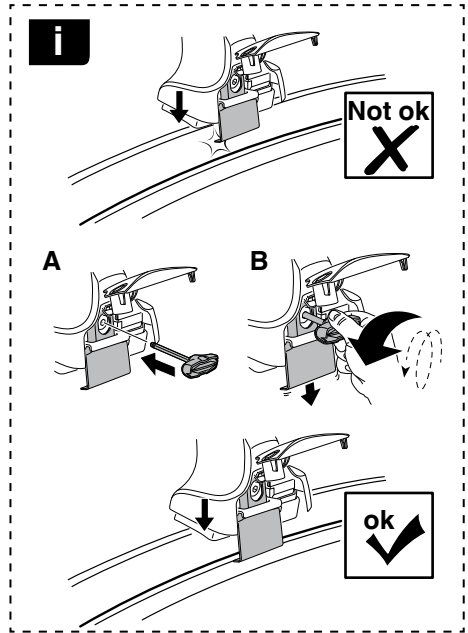
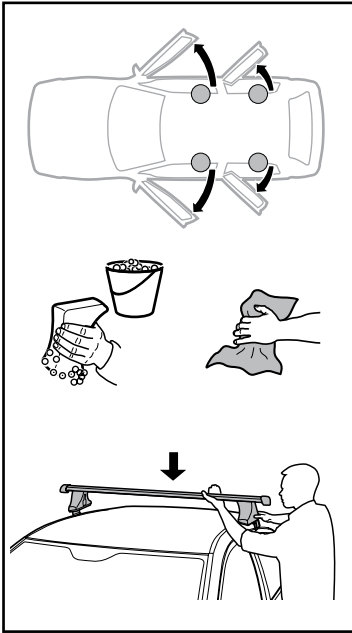

	X mm	Y mm	X inch	Y inch
HONDA Civic, 5-dr Hatchback, 06-11	250 mm	650 mm	9 7/8"	25 5/8"

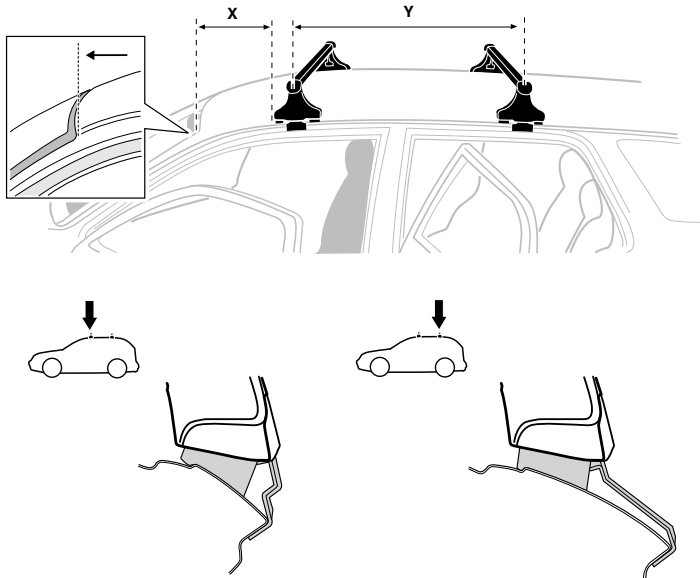

7

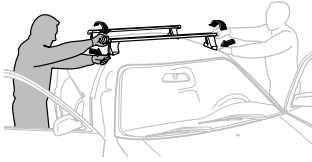

GB/US	Tighten alternately
D	Die Schrauben abwechselnd anziehen
F	Serrer alternativement chaque côté
NL	Afwisselend aan de linker- en de rechterkant aandraaien
I	Alternare il serraggio delle viti
E	Apretar alternativamente
PT	Aperte alternadamente
S	Dra åt växelvis
FIN	Kierrä vuorotellen
EST	Pinguldage vaheldumisi
LAT	Pielveiciet pamišus
LIT	Užsukinėkite pakaitomis
PL	Śruby dokręcaj naprzemiennie
RU	Затягивайте попеременно

CZ	Pokręťta багаžnika dokręcaj dokręcaj naprzemiennie.
SK	Dofahajte striedavo
SLO	Privijajte izmenično.
HR	Naizmenično zategnite
HU	Egymásról fűggetlenül szorítandó
GR	Σφιγγετε εναλλάξ
TR	Dönüşümlü sıkın

中文 交替拧紧

한국어 번갈아 가며 조이십시오.

日本語 交互に締め付けてください。

ไทย ขันในแบบสลับ

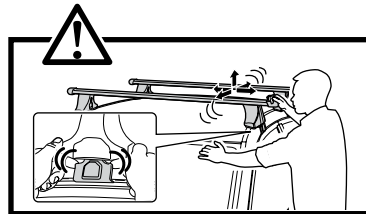
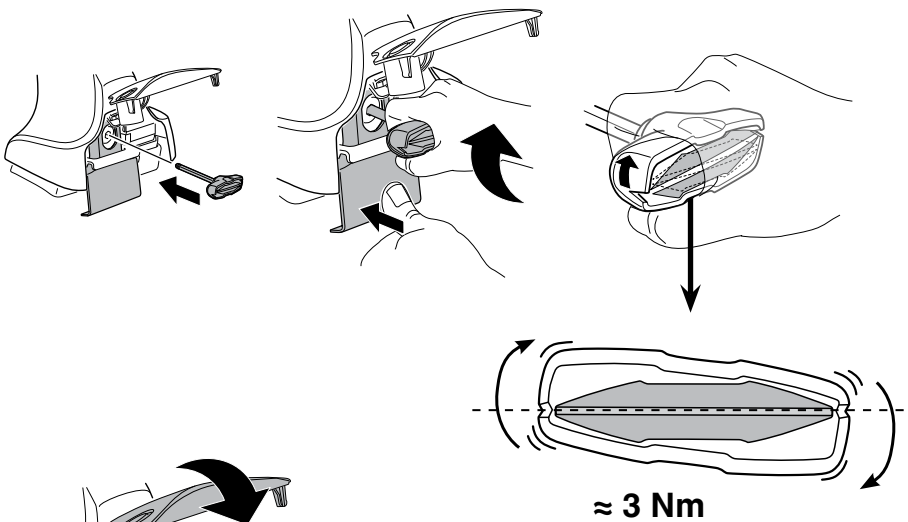

8



x1
17 mm

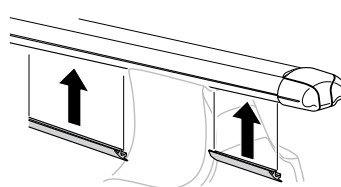
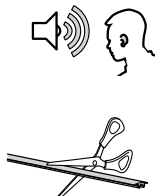

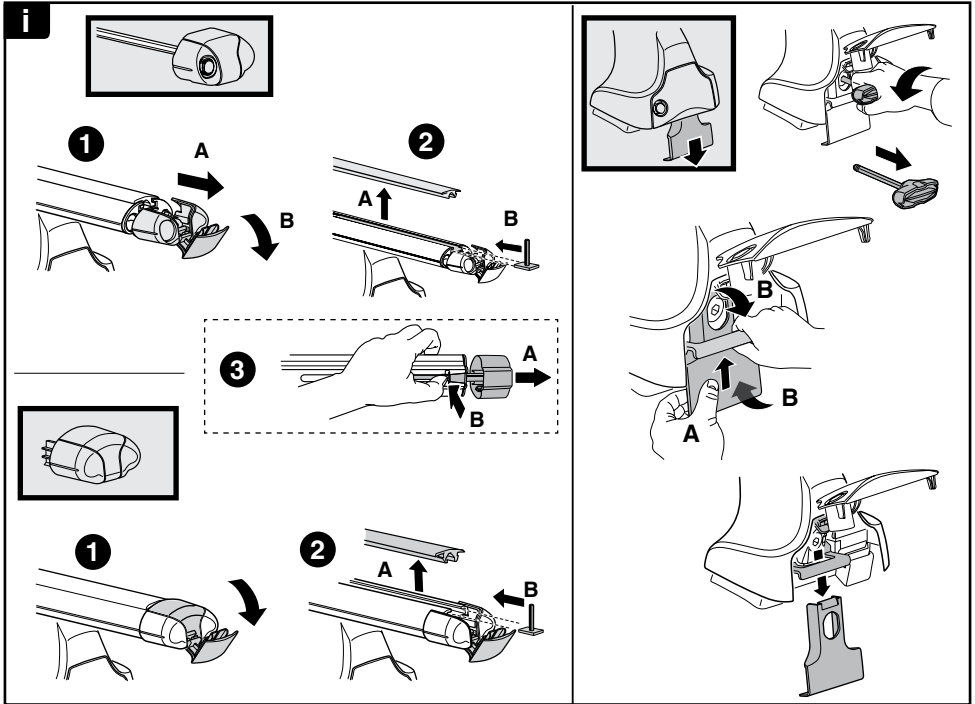
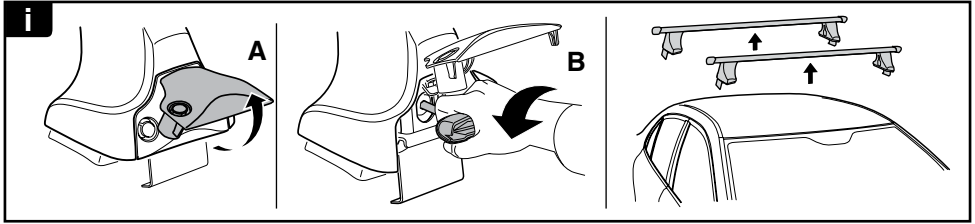

THULE
SWEDEN
**ONE
KEY
SYSTEM**

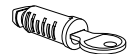
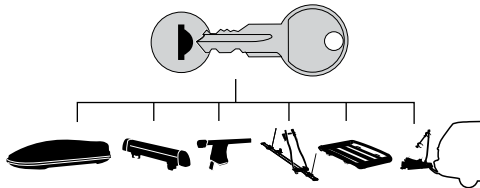

544 (x4)

596 (x6)

588 (x8)

NA **510** (x10)

EUR **452** (x12)

ASIA

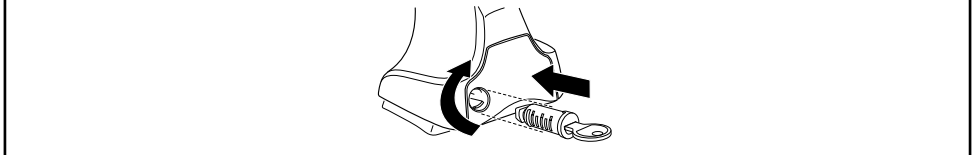

WW ▶ Thule Sweden AB, Box 69, 330 33 Hillerstorp, SWEDEN
NA ▶ Thule Inc., 42 Silvermine Road, Seymour, Connecticut 06483, USA

info@thule.com
customer.service@thule.com

www.thule.com