

Kit 1402

SUZUKI Escudo, 5-dr SUV, 05-*

SUZUKI Grand Vitara, 5-dr SUV, 05-*

* Without railing

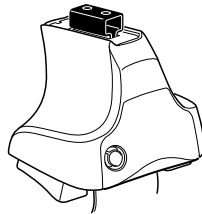

754 Rapid System
480R Rapid Traverse (North America)

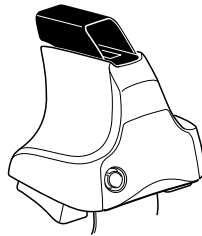
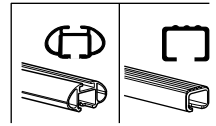

480 Traverse (North America)

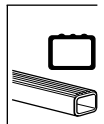

- 754 Rapid System: x4 (white cube), x4 (black strap)
- 480R Rapid Traverse (North America): x4 (black plastic part), x4 (screwdriver)
- 754 Rapid System: x1 (ruler)
- 480 Traverse (North America): x4 (black plastic part), x4 (screwdriver), x1 (ruler)

- Bar: x2
- Bracket 1: x2 (23 mm)
- Bracket 2: x2 (23 mm)
- Bracket 3: x1 (17 mm)
- Bracket 4: x2 (23 mm)
- Bracket 5: x2 (23 mm)
- Screw 1: x4
- Screw 2: x4
- Bracket 6: x2
- Bracket 7: x2
- Bracket 8: x2
- Bracket 9: x2
- Bracket 10: x2
- Bracket 11: x2
- Bracket 12: x2
- Bracket 13: x2
- Bracket 14: x2
- Bracket 15: x2
- Bracket 16: x2
- Bracket 17: x2
- Bracket 18: x2
- Bracket 19: x2
- Bracket 20: x2
- Bracket 21: x2
- Bracket 22: x2
- Bracket 23: x2
- Bracket 24: x2
- Bracket 25: x2
- Bracket 26: x2
- Bracket 27: x2
- Bracket 28: x2
- Bracket 29: x2
- Bracket 30: x2
- Bracket 31: x2
- Bracket 32: x2
- Bracket 33: x2
- Bracket 34: x2
- Bracket 35: x2
- Bracket 36: x2
- Bracket 37: x2
- Bracket 38: x2
- Bracket 39: x2
- Bracket 40: x2
- Bracket 41: x2
- Bracket 42: x2
- Bracket 43: x2
- Bracket 44: x2
- Bracket 45: x2
- Bracket 46: x2
- Bracket 47: x2
- Bracket 48: x2
- Bracket 49: x2
- Bracket 50: x2
- Bracket 51: x2
- Bracket 52: x2
- Bracket 53: x2
- Bracket 54: x2
- Bracket 55: x2
- Bracket 56: x2
- Bracket 57: x2
- Bracket 58: x2
- Bracket 59: x2
- Bracket 60: x2
- Bracket 61: x2
- Bracket 62: x2
- Bracket 63: x2
- Bracket 64: x2
- Bracket 65: x2
- Bracket 66: x2
- Bracket 67: x2
- Bracket 68: x2
- Bracket 69: x2
- Bracket 70: x2
- Bracket 71: x2
- Bracket 72: x2
- Bracket 73: x2
- Bracket 74: x2
- Bracket 75: x2
- Bracket 76: x2
- Bracket 77: x2
- Bracket 78: x2
- Bracket 79: x2
- Bracket 80: x2
- Bracket 81: x2
- Bracket 82: x2
- Bracket 83: x2
- Bracket 84: x2
- Bracket 85: x2
- Bracket 86: x2
- Bracket 87: x2
- Bracket 88: x2
- Bracket 89: x2
- Bracket 90: x2
- Bracket 91: x2
- Bracket 92: x2
- Bracket 93: x2
- Bracket 94: x2
- Bracket 95: x2
- Bracket 96: x2
- Bracket 97: x2
- Bracket 98: x2
- Bracket 99: x2
- Bracket 100: x2

- Bracket 1: x2 (761)
- Bracket 2: x2 (762)
- Plate: x4 (225)
- Diagram: x1 (RR, FR, EL, RL)

1

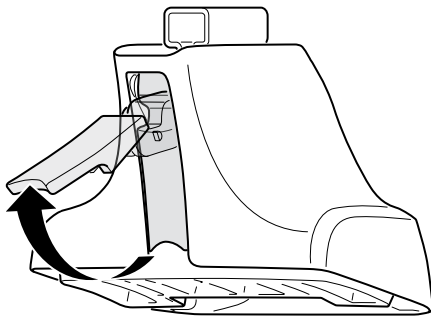

2



754 Rapid System
480R Rapid Traverse
(North America)

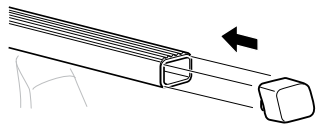
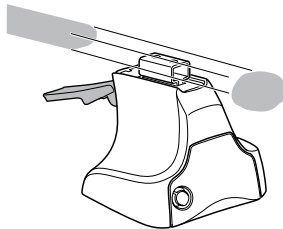

x4

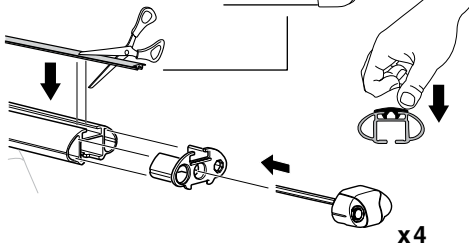
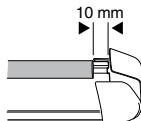
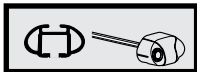

x4

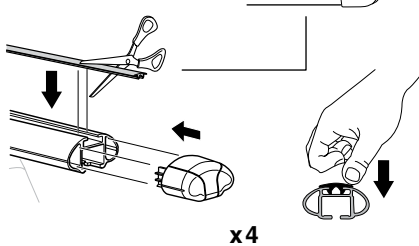
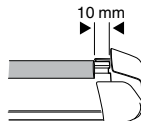
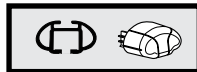

x4



480 Traverse
(North America)

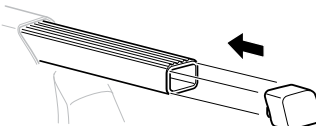
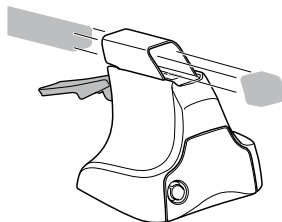

x4

3



754 Rapid System

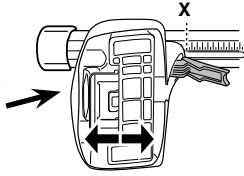

	X
SUZUKI Escudo, 5-dr SUV, 05-	42,5
SUZUKI Grand Vitara, 5-dr SUV, 05-	42,5

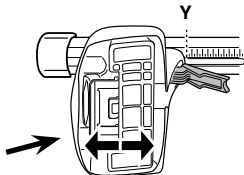

	Y
SUZUKI Escudo, 5-dr SUV, 05-	38,5
SUZUKI Grand Vitara, 5-dr SUV, 05-	38,5

3

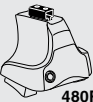

480R Rapid Traverse



480 Traverse

(North America)

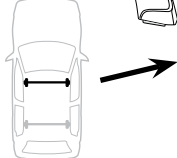

	X inch	X mm
SUZUKI Escudo, 5-dr SUV, 05-	42 ³ / ₈ "	1076 mm
SUZUKI Grand Vitara, 5-dr SUV, 05-	42 ³ / ₈ "	1076 mm

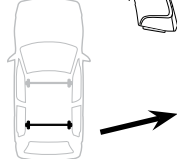
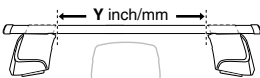

	Y inch	Y mm
SUZUKI Escudo, 5-dr SUV, 05-	40 ³ / ₄ "	1036 mm
SUZUKI Grand Vitara, 5-dr SUV, 05-	40 ³ / ₄ "	1036 mm

4

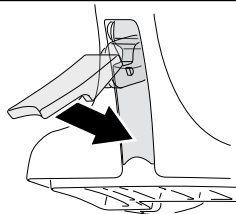

5

SUZUKI Escudo, 5-dr SUV, 05–
SUZUKI Grand Vitara, 5-dr SUV, 05–

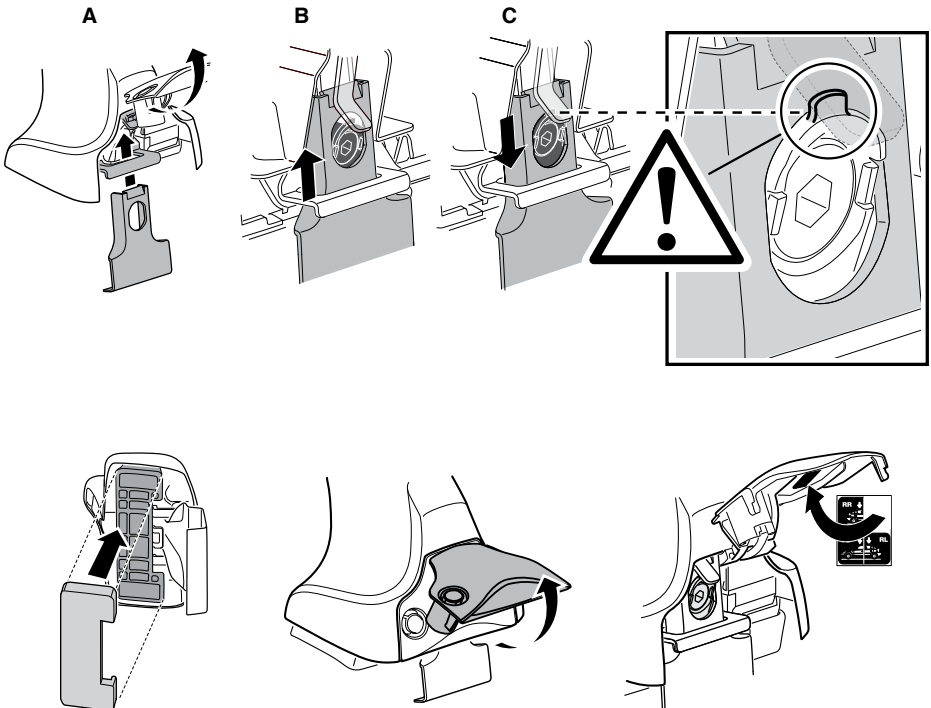
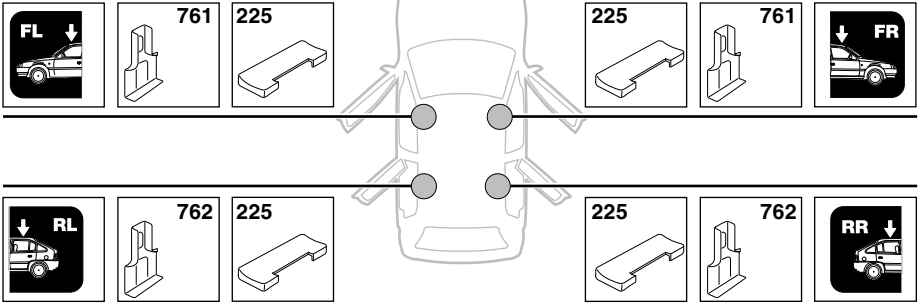

6

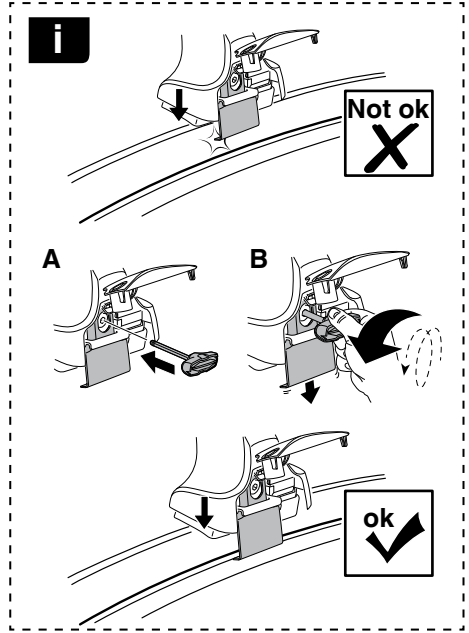

	X mm	Y mm	X inch	Y inch
SUZUKI Escudo, 5-dr SUV, 05-	265 mm	715 mm	10 ³ / ₈ "	28 ¹ / ₈ "
SUZUKI Grand Vitara, 5-dr SUV, 05-	265 mm	715 mm	10 ³ / ₈ "	28 ¹ / ₈ "

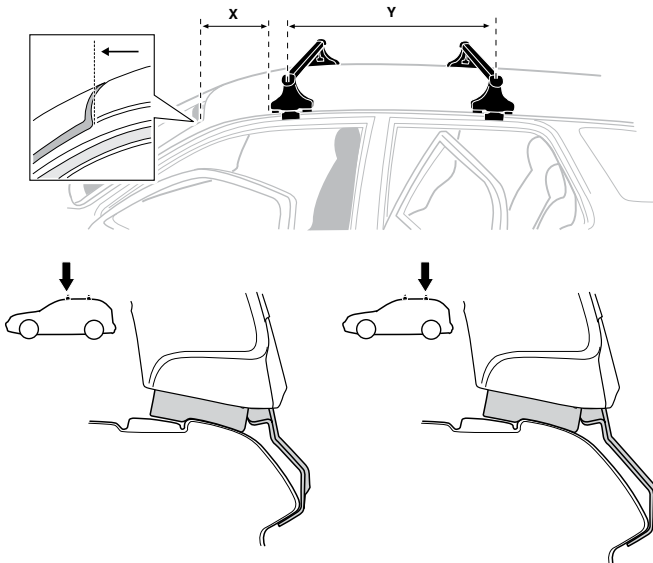

7

GB/US Tighten alternately
D Die Schrauben abwechselnd anziehen
F Serrer alternativement chaque côté
NL Afwisselend aan de linker- en de rechterkant aandraaien
I Alternare il serraggio delle viti
E Apertar alternativamente
PT Aperte alternadamente
S Dra åt växelvis
FIN Kierrä vuorotellen
EST Pinguldage vaheldumisi
LAT Pieļieciet pamišus
LIT Užsukinėkite pakaitomis
PL Śruby dokręcaj naprzemiennie
RU Затягивайте попеременно

CZ Pokręťta bagażnika dokręcaj naprzemiennie.
SK Dofahajte striedavo
SLO Privijajte izmenično.
HR Naizmjerno zategnite
HU Egymástól függetlenül szorítandó
GR Σφιγίγτες εναλλάξ
TR Dönüşümlü sıkın

中文 交替拧紧

한국어 번갈아 가며 조이십시오.

日本語 交互に締め付けてください。

ไทย ชันในแบบสลับ

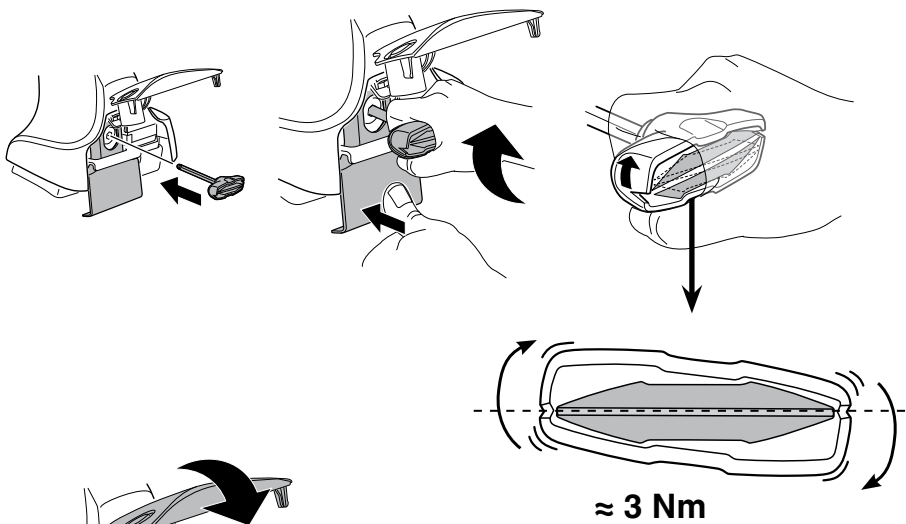
**8**

x1
17 mm

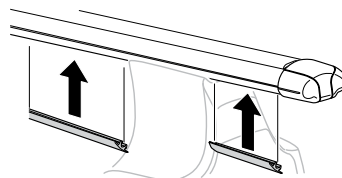
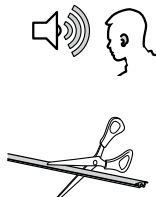

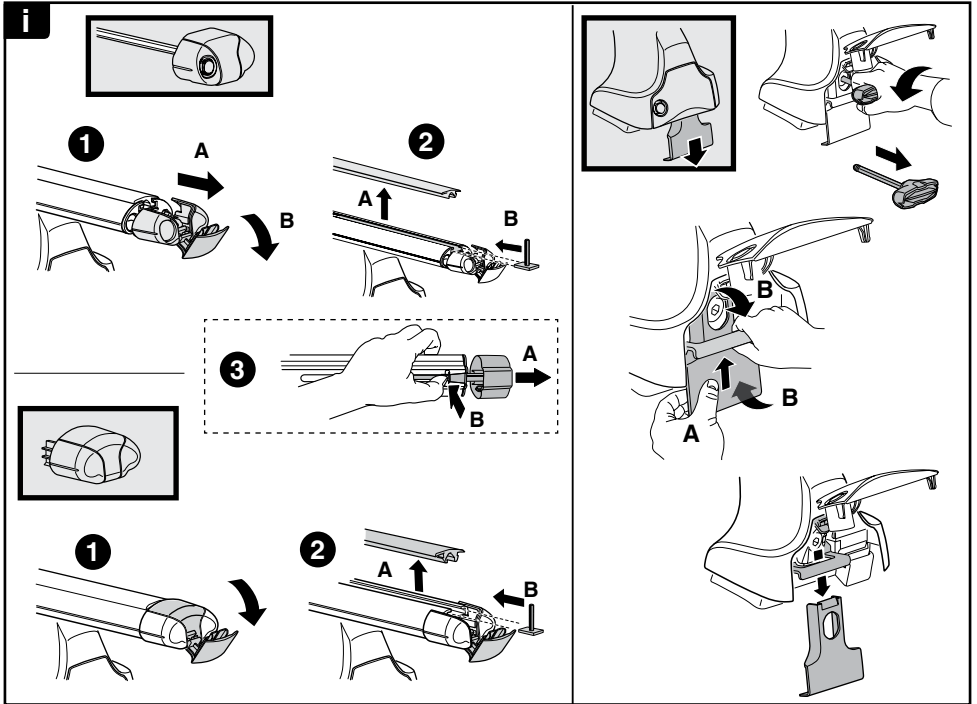
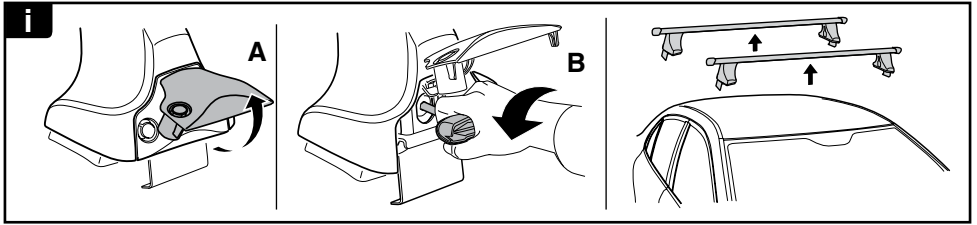

THULE
SWEDEN
**ONE
KEY
SYSTEM**

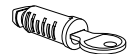
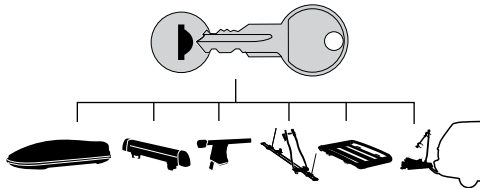

544 (x4)

596 (x6)

588 (x8)

NA **510** (x10)

EUR **452** (x12)

ASIA

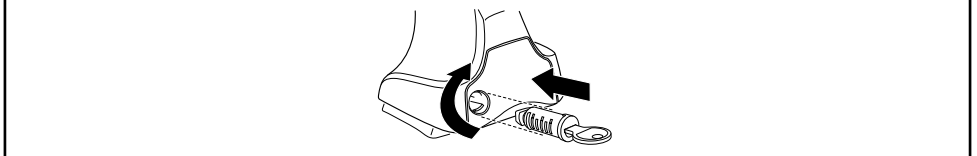

WW ▶ Thule Sweden AB, Box 69, 330 33 Hillerstorp, SWEDEN
NA ▶ Thule Inc., 42 Silvermine Road, Seymour, Connecticut 06483, USA

info@thule.com
customer.service@thule.com

www.thule.com

503-1402-02