

Kit 1304

HONDA Accord, 4-dr Sedan, 03-07
HONDA Accord, 4-dr Sedan, *03-07
ACURA TSX, 4-dr Sedan, *04-08

*North America

480R
754

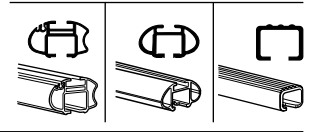
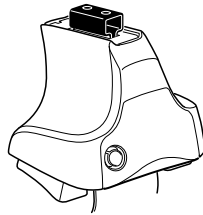

480

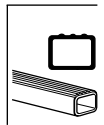
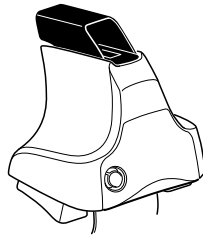

750

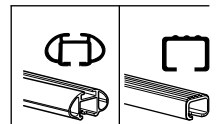
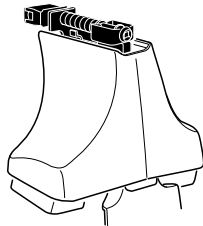

THULE[®]
SWEDEN

ISO 11154-E

x2 x2 x2 x4	x2	x2 x2 x4 x4	x2 x2	x2	x2

32 x 2

546 x 4

140 x 1

141 x 1

x 1

Kit

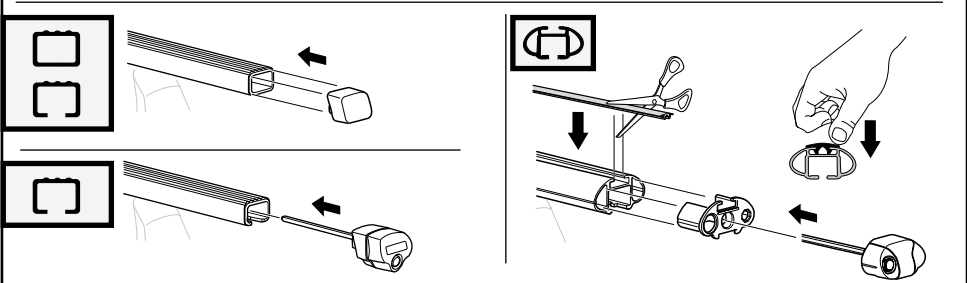
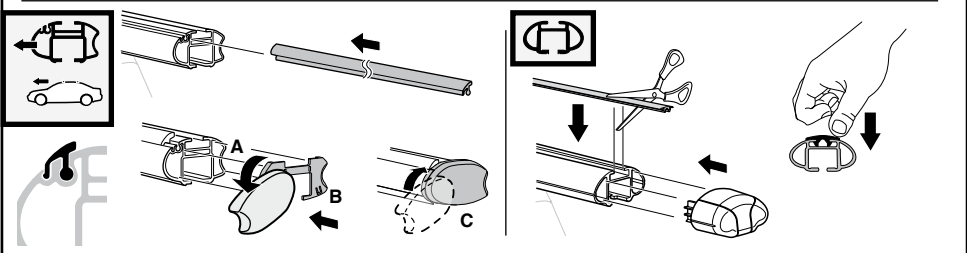
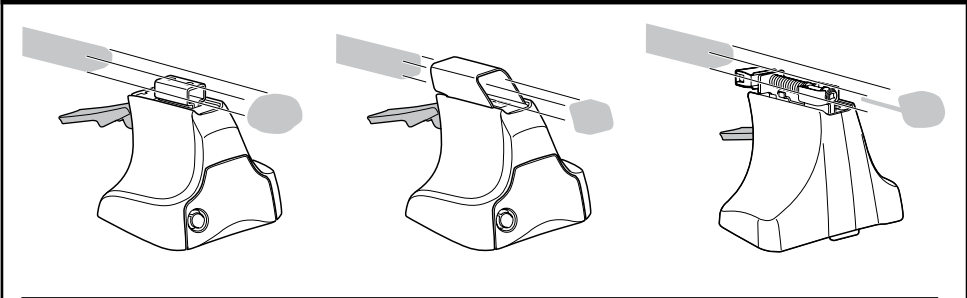

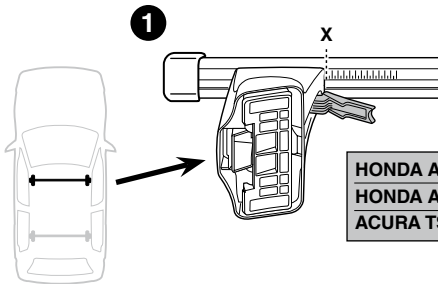
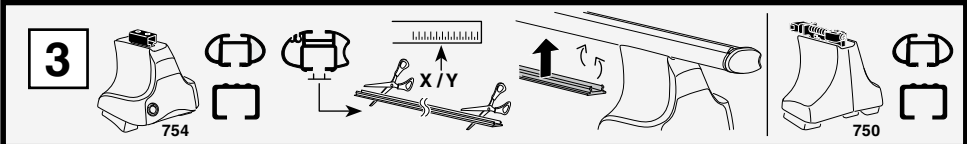

	X
HONDA Accord, 4-dr Sedan, 03-07	34
HONDA Accord, 4-dr Sedan, *03-07	32,5
ACURA TSX, 4-dr Sedan, *04-08	32,5

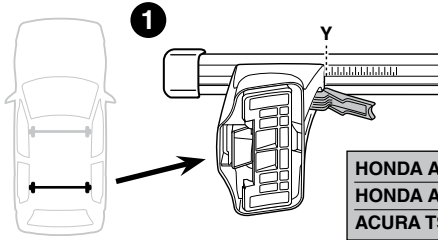
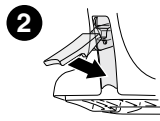

	Y
HONDA Accord, 4-dr Sedan, 03-07	32
HONDA Accord, 4-dr Sedan, *03-07	36
ACURA TSX, 4-dr Sedan, *04-08	36

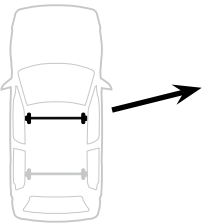
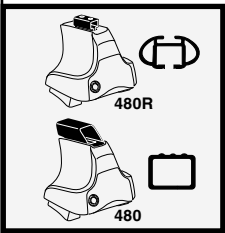
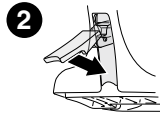

	X inch	X mm
HONDA Accord, 4-dr Sedan, 03-07	39"	991 mm
HONDA Accord, 4-dr Sedan, *03-07	38 1/2"	976 mm
ACURA TSX, 4-dr Sedan, *04-08	38 1/2"	976 mm

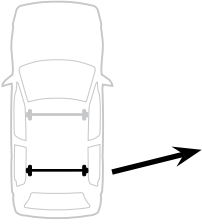
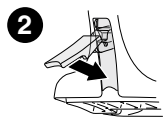

	Y inch	Y mm
HONDA Accord, 4-dr Sedan, 03-07	38 1/4"	971 mm
HONDA Accord, 4-dr Sedan, *03-07	39 1/4"	1011 mm
ACURA TSX, 4-dr Sedan, *04-08	39 1/4"	1011 mm

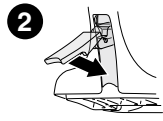

4

HONDA Accord, 4-dr Sedan, 03-07

HONDA Accord, 4-dr Sedan, *03-07

ACURA TSX, 4-dr Sedan, *04-08

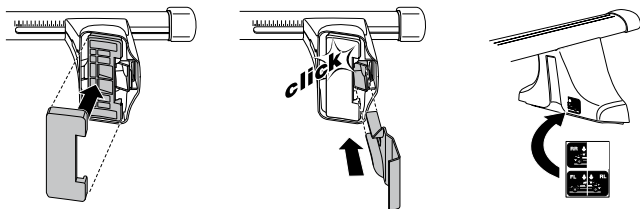
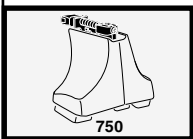
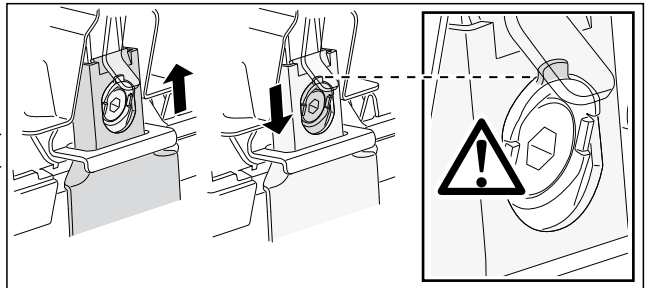
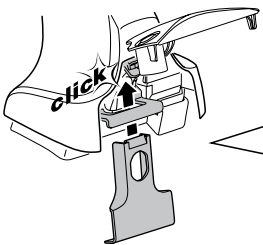
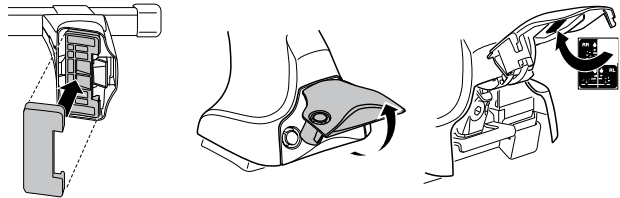
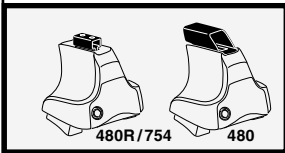
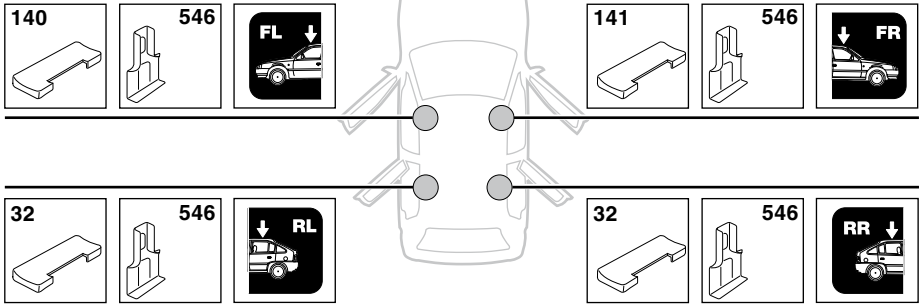

5

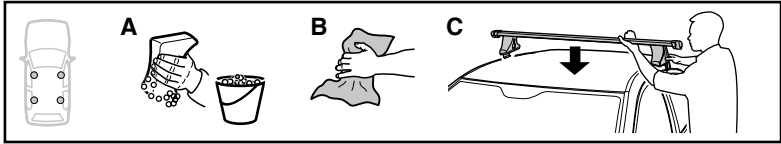

	X mm	Y mm	X inch	Y inch
HONDA Accord, 4-dr Sedan, *03-07	250 mm	680 mm	9 7/8"	26 3/4"
HONDA Accord, 4-dr Sedan, *03-07	250 mm	680 mm	9 7/8"	26 3/4"
ACURA TSX, 4-dr Sedan, *04-08	250 mm	680 mm	9 7/8"	26 3/4"

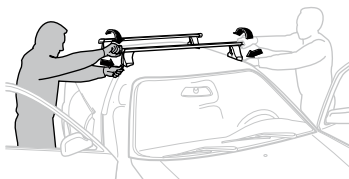
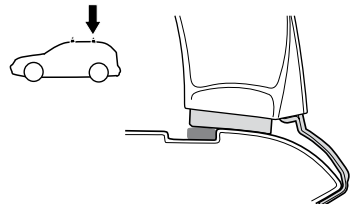
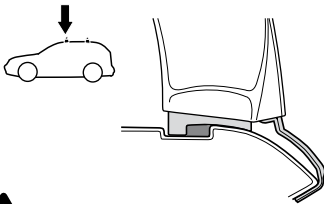
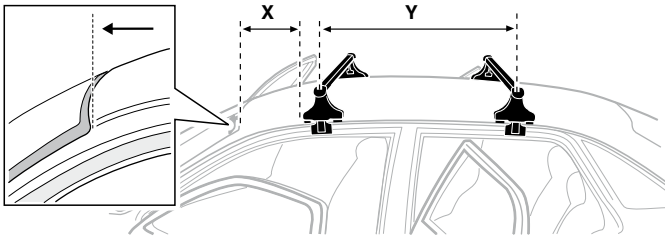

GB/US Tighten alternately

D Die Schrauben abwechselnd anziehen

F Serrer alternativement chaque côté

NL Afwisselend aan de linker- en de rechterkant aandraaien

I Alternare il serraggio delle viti

E Serrare alternativamente

PT Aperte alternadamente

S Dra åt växelvis

FIN Kierrä vuorotellen

EST Pinguldage vaheldumisi

LAT Pielvelciet pamišus

LIT Užsukinėkite pakaitomis

PL Śruby dokręcaj naprzemiennie

RU Затягивайте попеременно

CZ Pokręťta bagazníka dokręcaj dokręcaj naprzemiennie.

SK Doťahujte striedavo

SLO Privijajte izmenično.

HR Naizmjenično zategnite

HU Egymástól függetlenül szorítandó

GR Σφιγγετε εναλλάξ

TR Dönüşümlü sıkın

中文 交替拧紧

한국어 번갈아 가며 조이십시오.

日本語 交互に締め付けてください。

ไทย ชันโนแบบสลับ

6

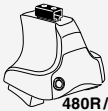

480R/754



480

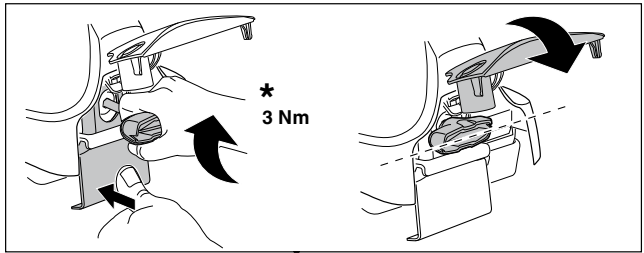
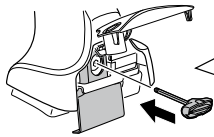

*
3 Nm

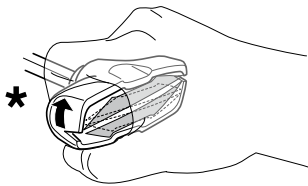

*

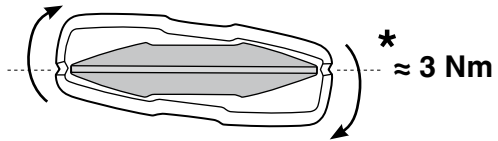

*
≈ 3 Nm

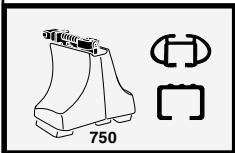
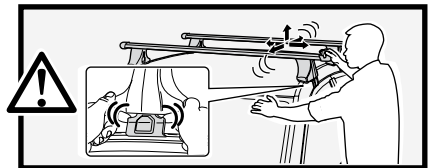

750

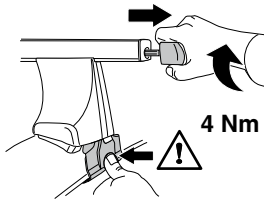

4 Nm

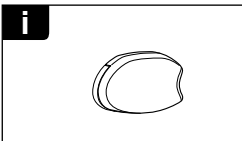
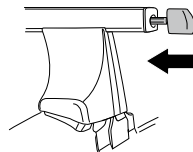

i

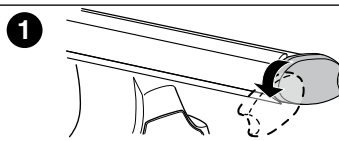

1

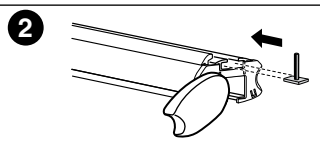

2

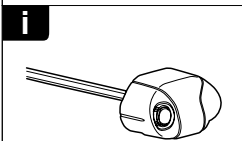

i

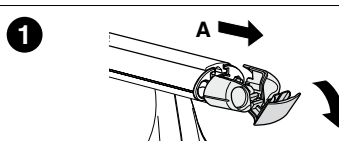

1

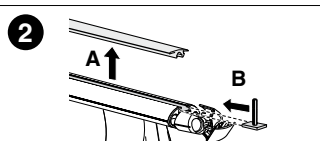

2

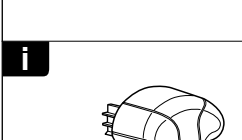

i

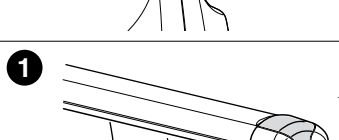

1

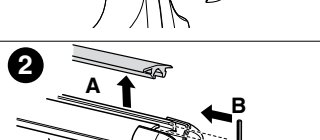

2

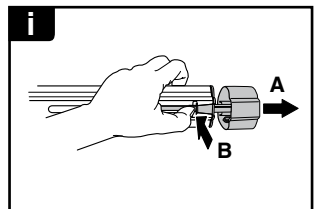
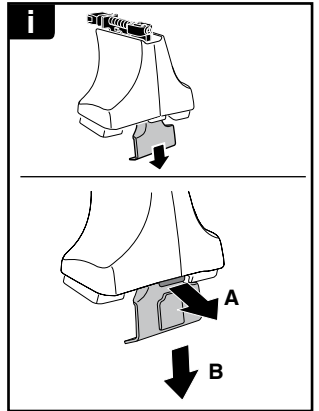
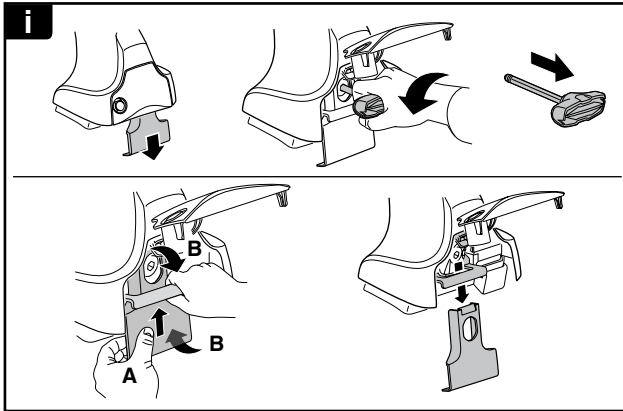
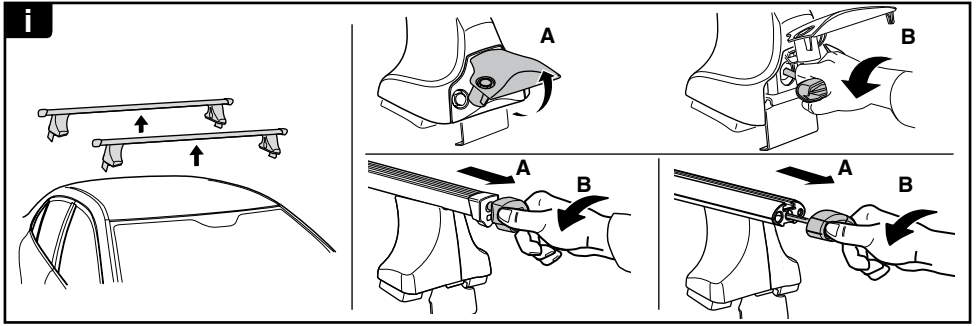

THULE
SWEDEN
**ONE
KEY
SYSTEM**

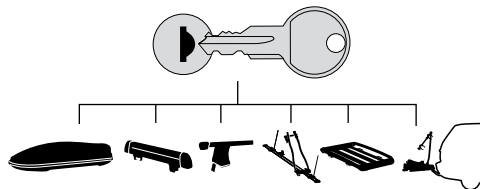

- 544 (x4)
- 596 (x6)
- 588 (x8)
- NA 510 (x10)
- EUR 452 (x12)
- ASIA

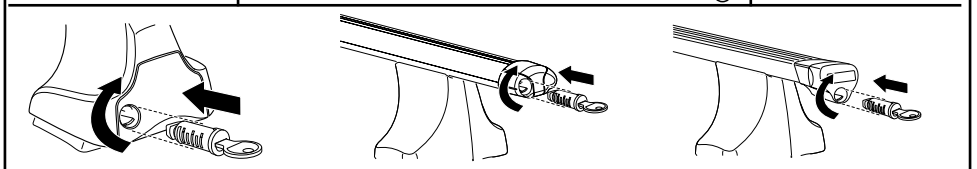

WW ▶ Thule Sweden AB, Box 69, 330 33 Hillerstorp, SWEDEN
NA ▶ Thule Inc., 42 Silvermine Road, Seymour, Connecticut 06483, USA

info@thule.com
customer.service@thule.com

www.thule.com