

Kit 1218

VOLKSWAGEN Passat, 4-dr Sedan, 01-04 / *02-05

*North America

480R
754

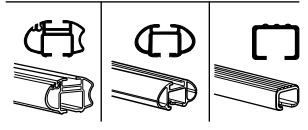
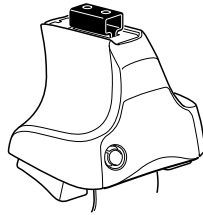

480

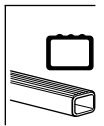
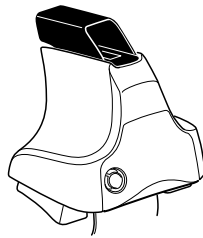

750

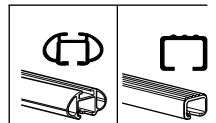
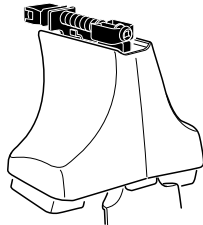

THULE[®]
SWEDEN

ISO 11154-E

x2 x2 x2 x2 x4	x2	x2 x2 x4 x4	x2 x2	x2

Kit

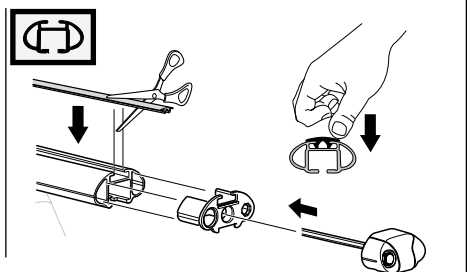
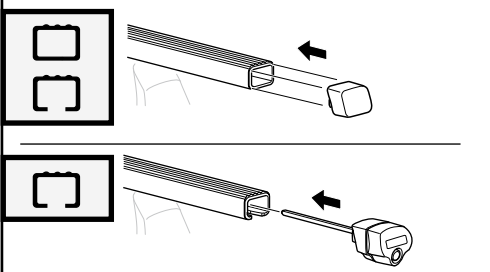
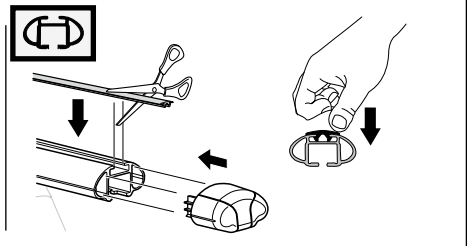
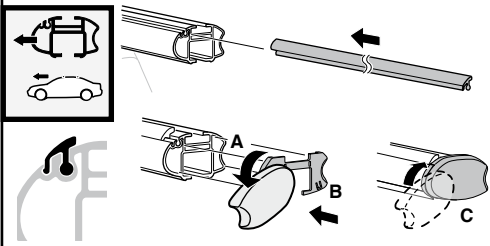
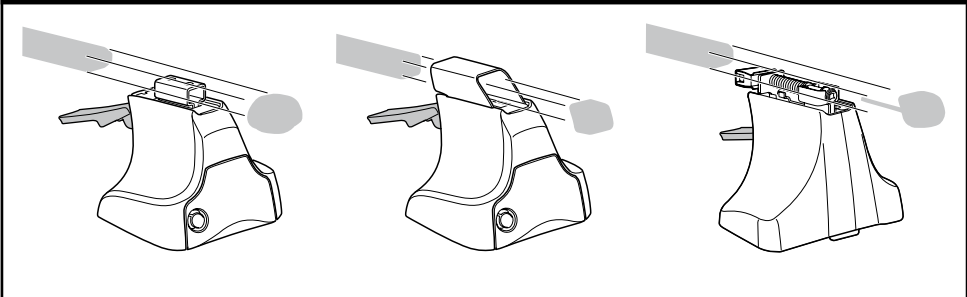

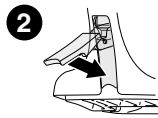
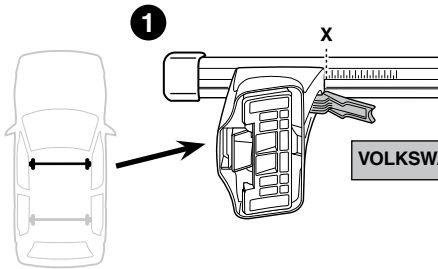
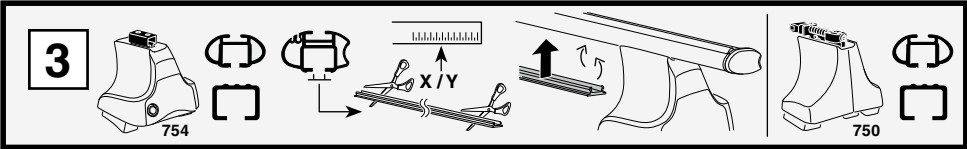

VOLKSWAGEN Passat, 4-dr Sedan, 01-04 / *02-05	X
	34

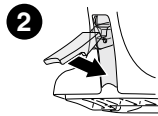
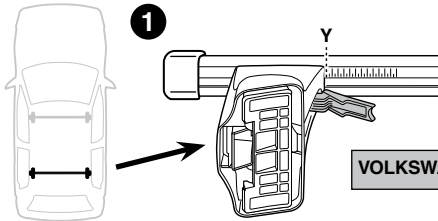

VOLKSWAGEN Passat, 4-dr Sedan, 01-04 / *02-05	Y
	33

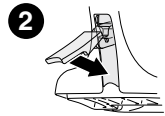
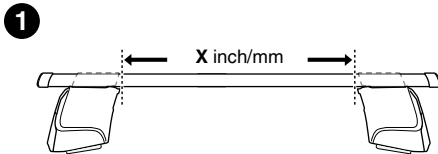
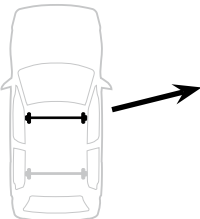
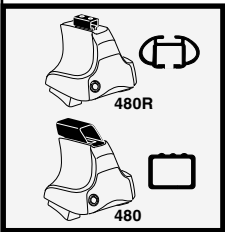

VOLKSWAGEN Passat, 4-dr Sedan, 01-04 / *02-05	X inch	X mm
	39"	991 mm

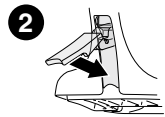
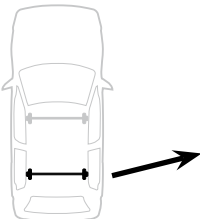

VOLKSWAGEN Passat, 4-dr Sedan, 01-04 / *02-05	Y inch	Y mm
	38 5/8"	981 mm

4

VOLKSWAGEN Passat, 4-dr Sedan, 01-04 / *02-05

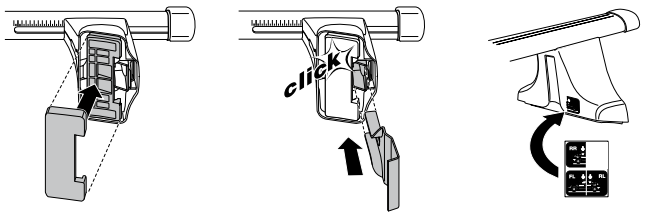
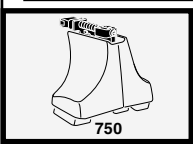
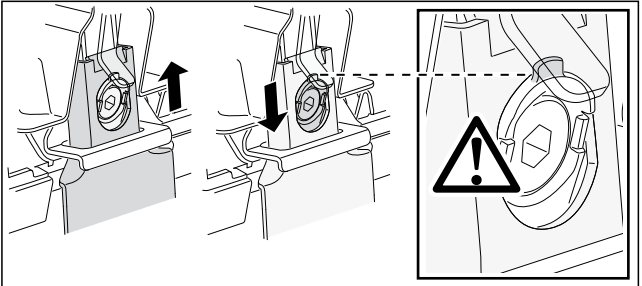
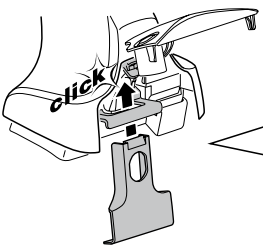
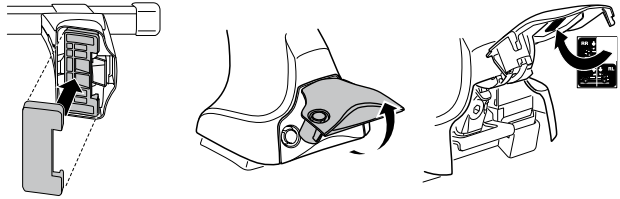
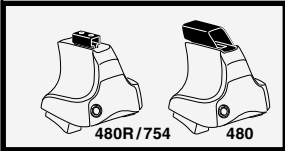
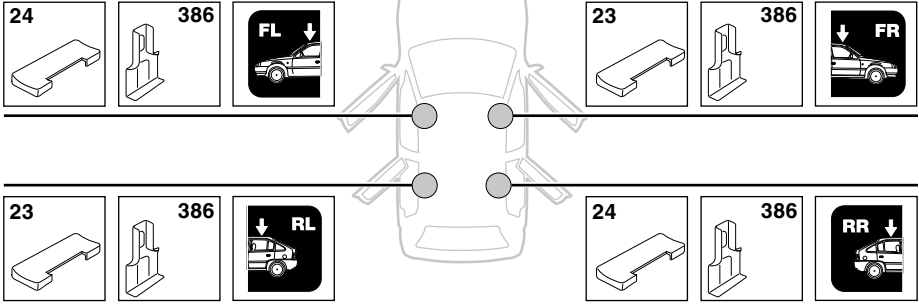

5

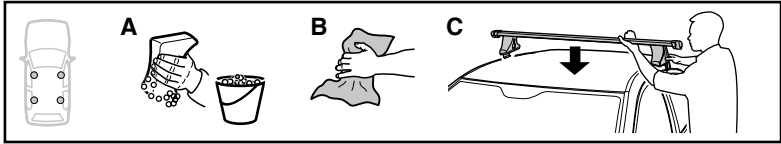

	X mm	Y mm	X inch	Y inch
VOLKSWAGEN Passat, 4-dr Sedan, 01-04 / *02-05	280 mm	680 mm	11"	26 3/4"

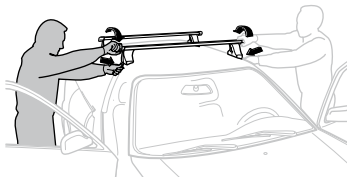
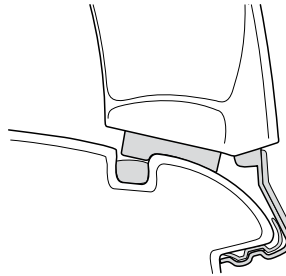
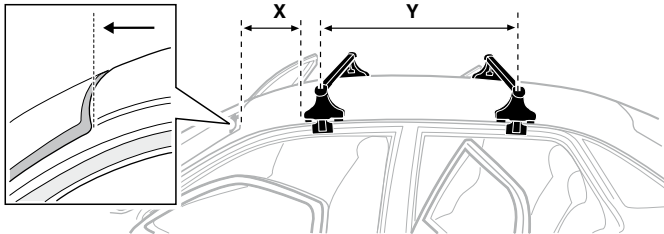

GB/US Tighten alternately

D Die Schrauben abwechselnd anziehen

F Serrer alternativement chaque côté

NL Afwisselend aan de linker- en de rechterkant aandraaien

I Alternare il serraggio delle viti

E Serrare alternativamente

PT Aperte alternadamente

S Dra åt växelvis

FIN Kierrä vuorotellen

EST Pinguldage vaheldumisi

LAT Pieveļciēt pamišus

LIT Užsukinėkite pakaitomis

PL Śruby dokręcaj naprzemiennie

RU Затягивайте попеременно

CZ Pokręťta багаžníka dokręcaj dokręcaj naprzemiennie.

SK Doťahujte striedavo

SLO Privijajte izmenično.

HR Naizmjenično zategnite

HU Egymástól függetlenül szorítandó

GR Σφιγγετε εναλλάξ

TR Dönüşümlü sıkın

中文 交替拧紧

한국어 번갈아 가며 조이십시오.

日本語 交互に締め付けてください。

ไทย ชันโนแบบสลับ

6

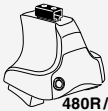

480R/754



480

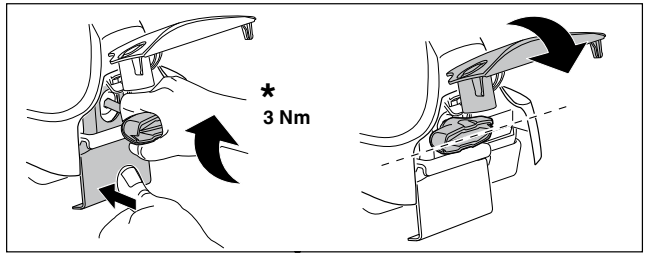
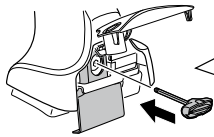

*
3 Nm

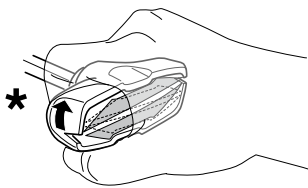

*

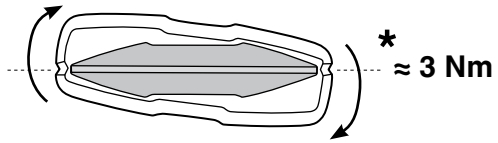

*
≈ 3 Nm

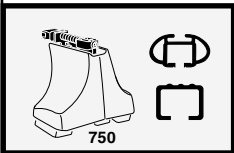
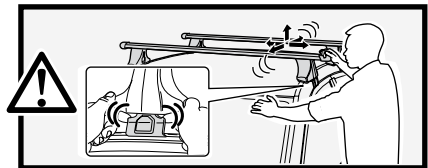

750

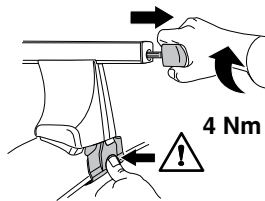

4 Nm

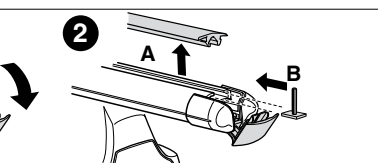
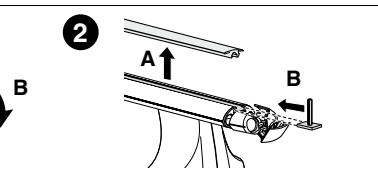
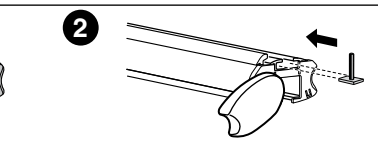
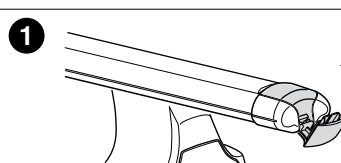
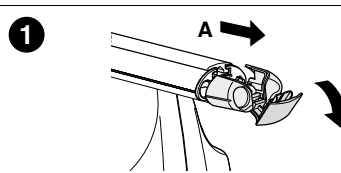
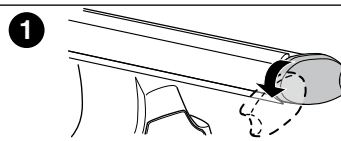
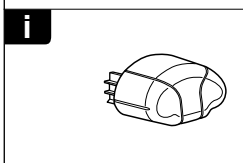
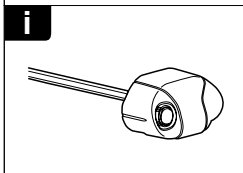
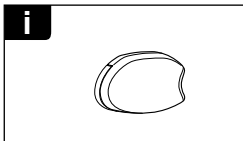
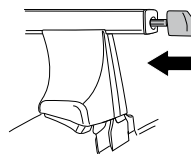

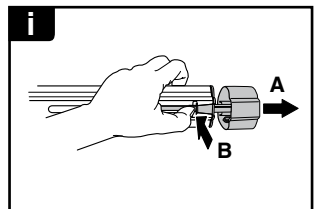
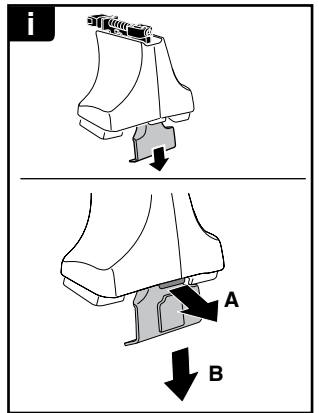
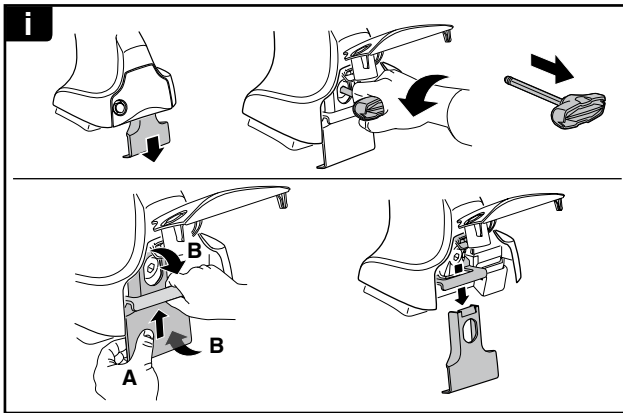
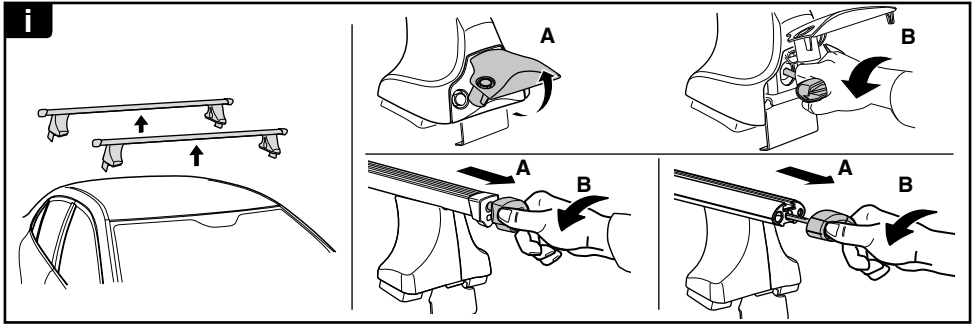

THULE
SWEDEN
**ONE
KEY
SYSTEM**

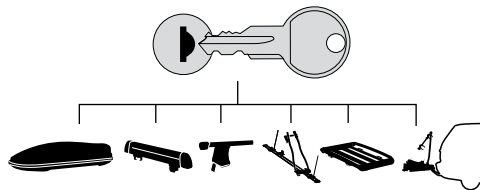

- 544 (x4)
- 596 (x6)
- 588 (x8)
- NA 510 (x10)
- EUR 452 (x12)
- ASIA

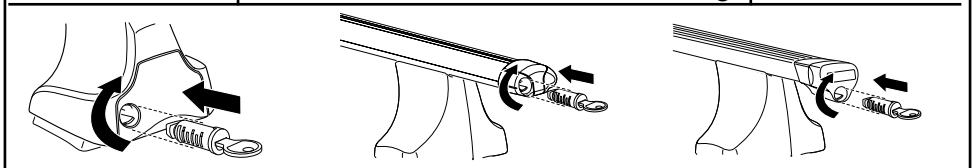

ww ▶ Thule Sweden AB, Box 69, 330 33 Hillerstorp, SWEDEN
 NA ▶ Thule Inc., 42 Silvermine Road, Seymour, Connecticut 06483, USA

info@thule.com
 customer.service@thule.com

www.thule.com