

# Kit 1203

CHRYSLER PT Cruiser, 5-dr Estate, 00-09

DAEWOO Musso, 5-dr SUV, 93-05

SSANGYONG Musso, 5-dr SUV, 93-05

480R  
754

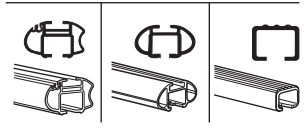
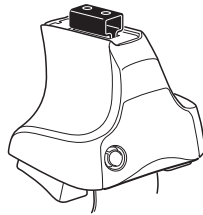

480

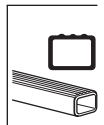
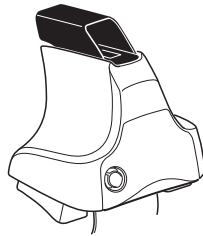

750

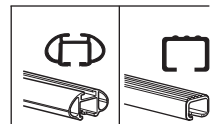
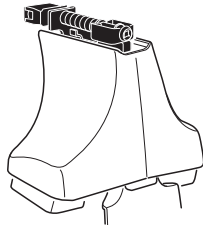

CHRYSLER PT Cruiser, 5-dr Estate, 00-09

Max.  
75 kg/165 lbs



DAEWOO Musso, 5-dr SUV, 93-05  
SSANGYONG Musso, 5-dr SUV, 93-05

Max.  
50 kg/110 lbs

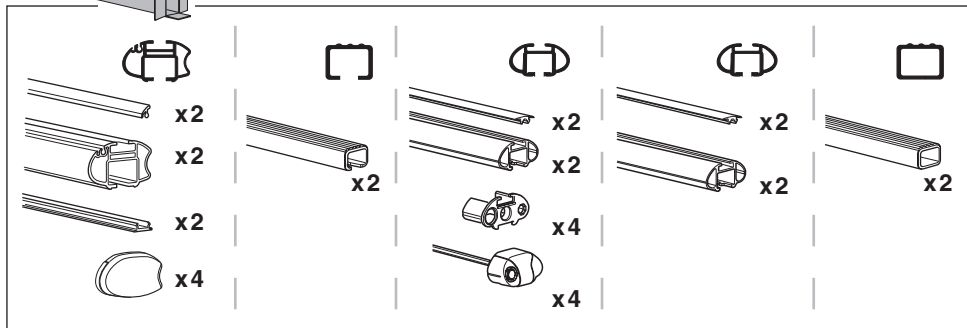
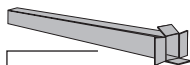
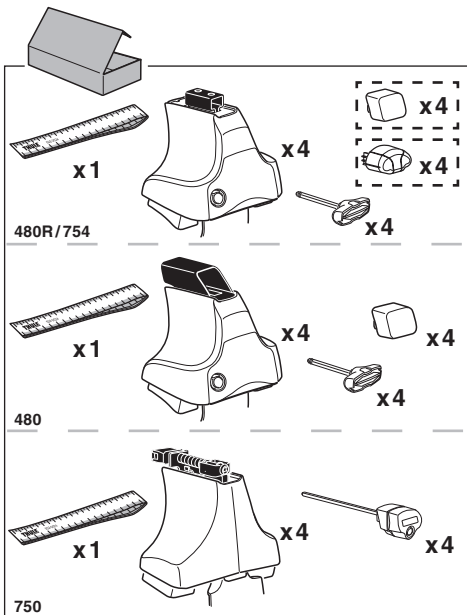
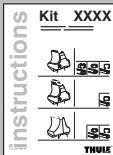

363 x 4

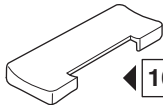

16 x 4



x 1

**Kit**

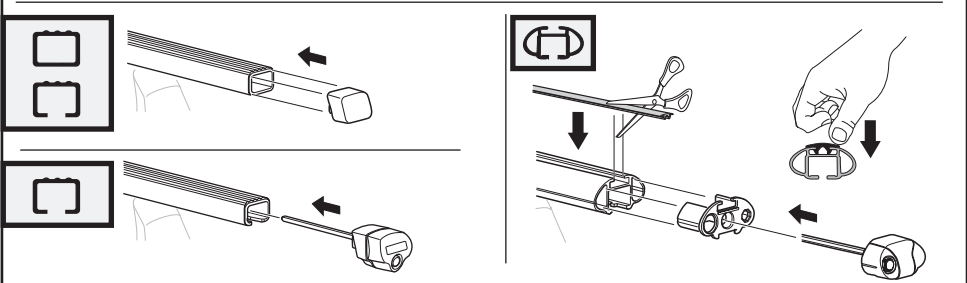
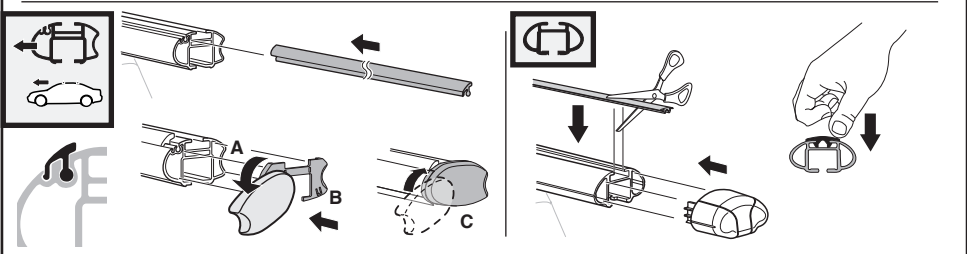
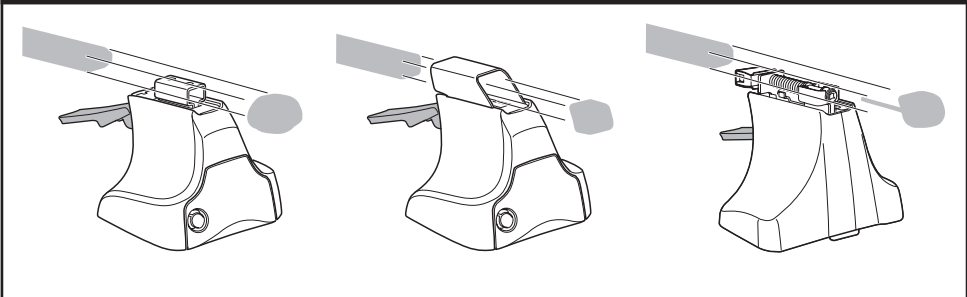
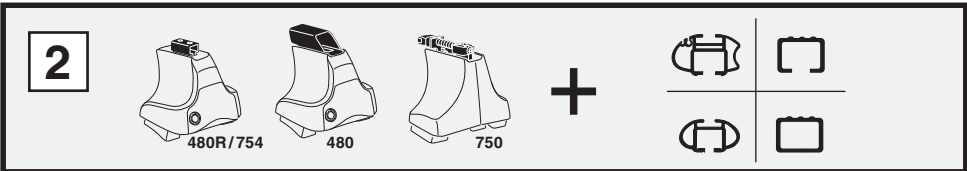
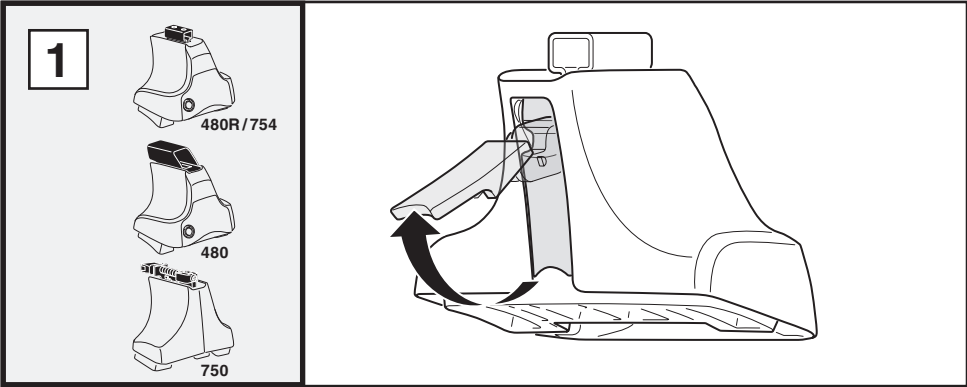

3

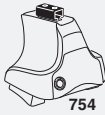

754

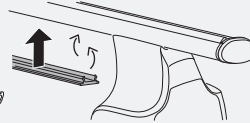
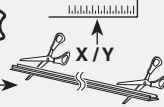

750



1

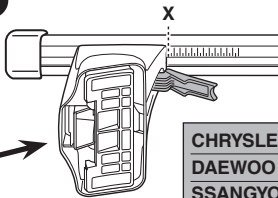
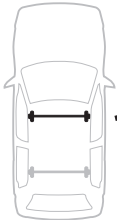

2

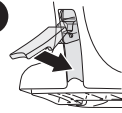

	X
CHRYSLER PT Cruiser, 5-dr Estate, 00-09	32,5
DAEWOO Musso, 5-dr SUV, 93-05	39
SSANGYONG Musso, 5-dr SUV, 93-05	39

1

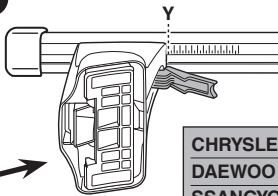
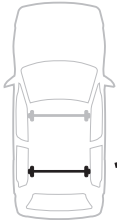

2

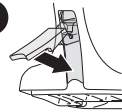

	Y
CHRYSLER PT Cruiser, 5-dr Estate, 00-09	28
DAEWOO Musso, 5-dr SUV, 93-05	38,5
SSANGYONG Musso, 5-dr SUV, 93-05	38,5



480R



480

1

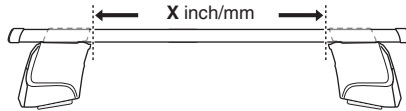

2

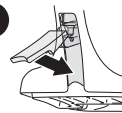

	X inch	X mm
CHRYSLER PT Cruiser, 5-dr Estate, 00-09	38 <sup>3</sup> / <sub>8</sub> "	976 mm
DAEWOO Musso, 5-dr SUV, 93-05	41 "	1041 mm
SSANGYONG Musso, 5-dr SUV, 93-05	41 "	1041 mm



1

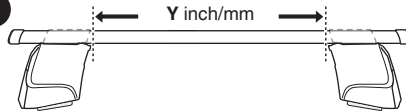

2

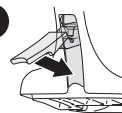

	Y inch	Y mm
CHRYSLER PT Cruiser, 5-dr Estate, 00-09	36 <sup>5</sup> / <sub>8</sub> "	931 mm
DAEWOO Musso, 5-dr SUV, 93-05	40 <sup>3</sup> / <sub>4</sub> "	1036 mm
SSANGYONG Musso, 5-dr SUV, 93-05	40 <sup>3</sup> / <sub>4</sub> "	1036 mm

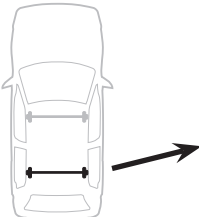

# 4

CHRYSLER PT Cruiser, 5-dr Estate, 00-09

DAEWOO Musso, 5-dr SUV, 93-05

SSANGYONG Musso, 5-dr SUV, 93-05

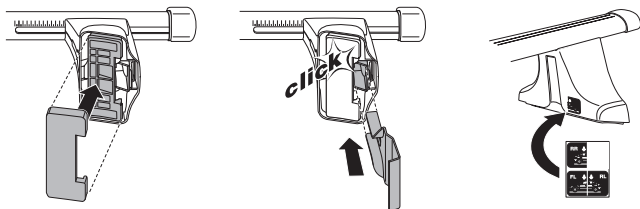
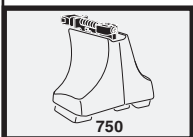
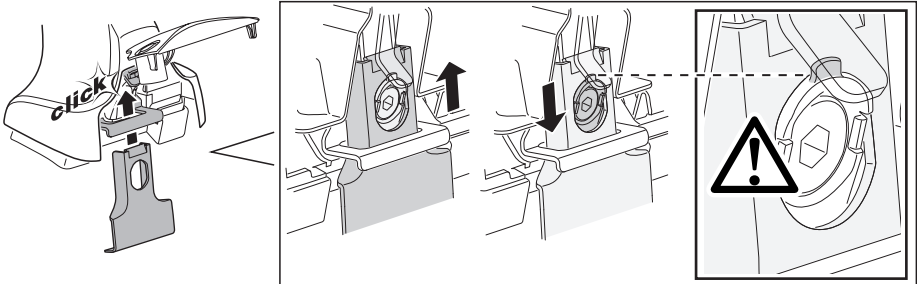
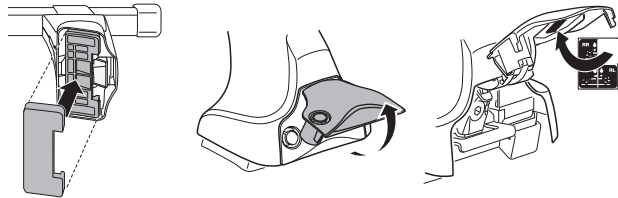
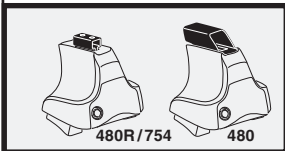
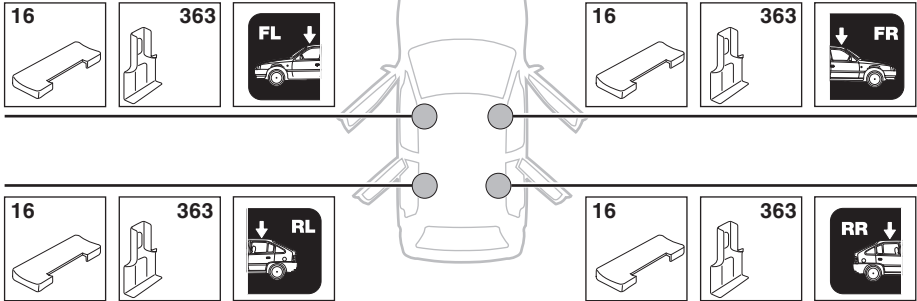

5

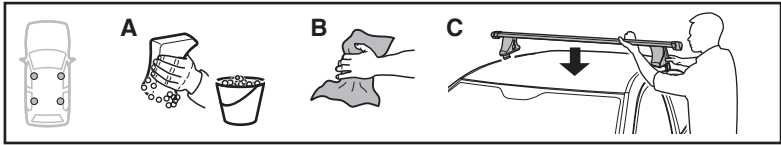

	X mm	Y mm	X inch	Y inch
<b>CHRYSLER PT Cruiser, 5-dr Estate, 00-09</b>	<b>290 mm</b>	<b>700 mm</b>	<b>11 3/8"</b>	<b>27 1/2"</b>
<b>DAEWOO Musso, 5-dr SUV, 93-05</b>	<b>300 mm</b>	<b>700 mm</b>	<b>11 3/4"</b>	<b>27 1/2"</b>
<b>SSANGYONG Musso, 5-dr SUV, 93-05</b>	<b>300 mm</b>	<b>700 mm</b>	<b>11 3/4"</b>	<b>27 1/2"</b>

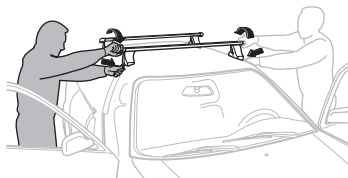
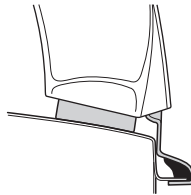
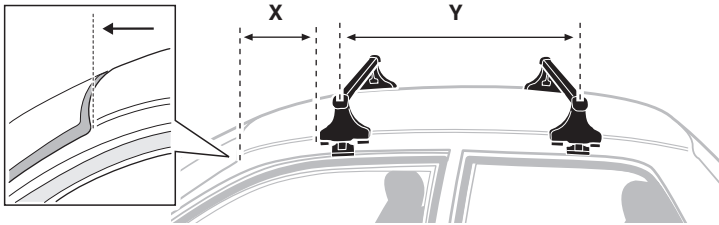

**GB/US** Tighten alternately

**D** Die Schrauben abwechselnd anziehen

**F** Serrer alternativement chaque côté

**NL** Afwisselend aan de linker- en de rechterkant aandraaien

**I** Alternare il serraggio delle viti

**E** Serrare alternativamente

**PT** Aperte alternadamente

**S** Dra åt växelvis

**FIN** Kierrä vuorotellen

**EST** Pinguldage vaheldumisi

**LAT** Pielvelciet pamīšus

**LIT** Užsukinėkite pakaitomis

**PL** Śruby dokręcaj naprzemiennie

**RU** Затягивайте попеременно

**CZ** Pokręťta bagażníka dokręcaj dokręcaj naprzemiennie.

**SK** Doťahujte striedavo

**SLO** Privijajte izmenično.

**HR** Naizmjenično zategnite

**HU** Egymástól függetlenül szorítandó

**GR** Σφίγγετε εναλλάξ

**TR** Dönüşümlü sıkın

**中文** 交替拧紧

**한국어** 번갈아 가며 조이십시오.

**日本語** 交互に締め付けてください。

**ไทย** ชั้้นโน้บแบบสลับ

6



480R/754



480

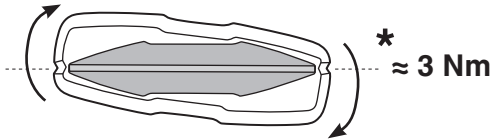
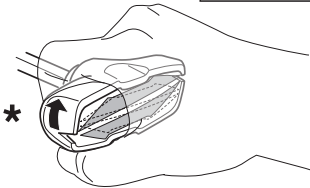
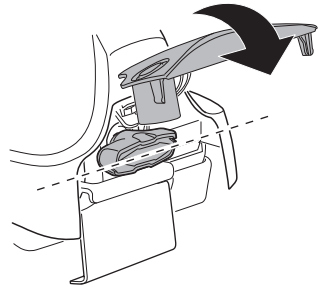
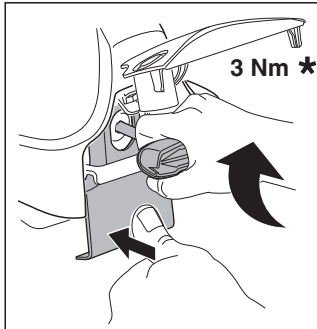
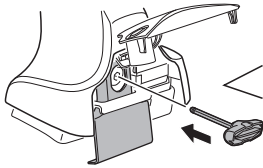

750

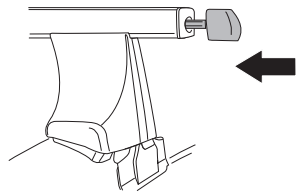
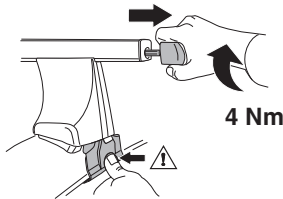

i



1



2

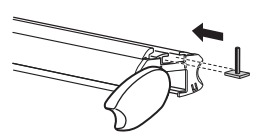

i

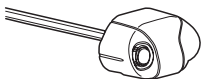

1

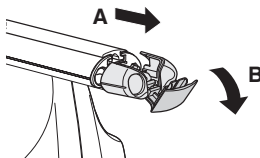

2

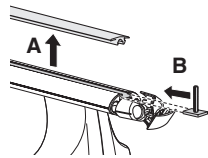

i



1

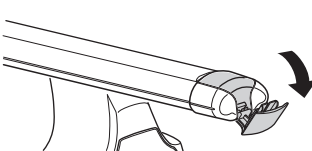

2

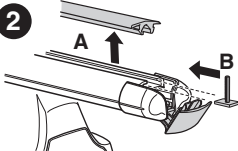

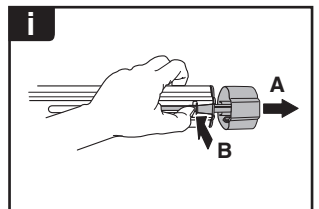
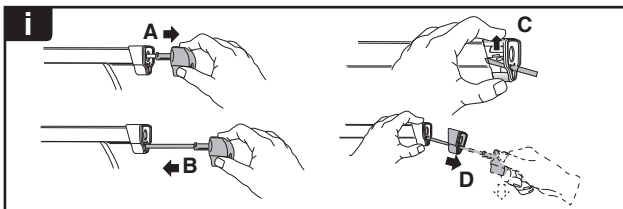
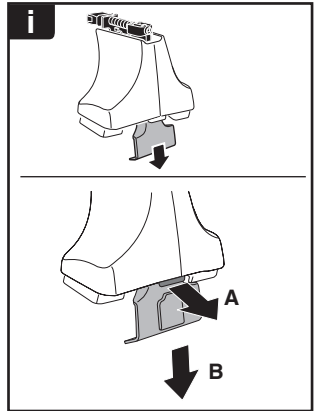
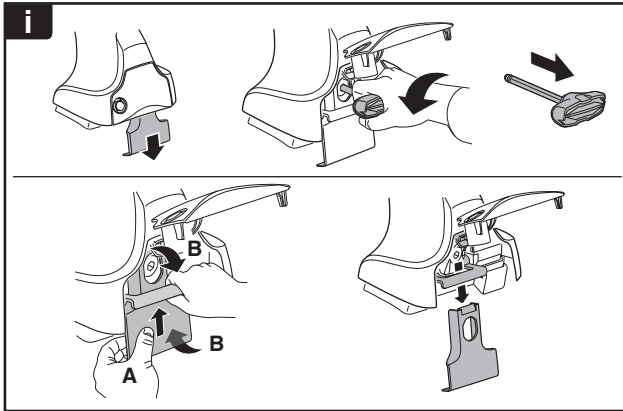
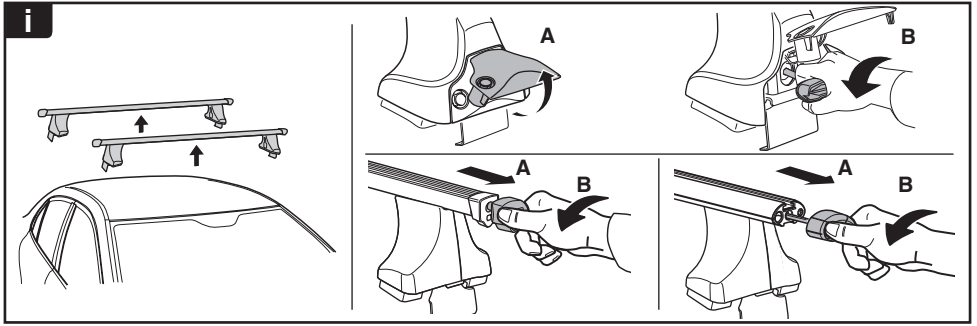

**THULE**  
SWEDEN  
**ONE  
KEY  
SYSTEM**

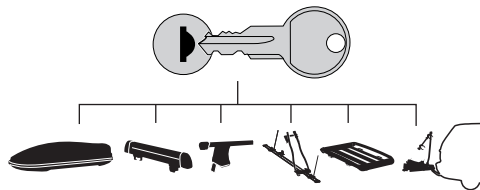

- 544 (x4)
- 596 (x6)
- 588 (x8)
- NA 510 (x10)
- EUR 452 (x12)
- ASIA

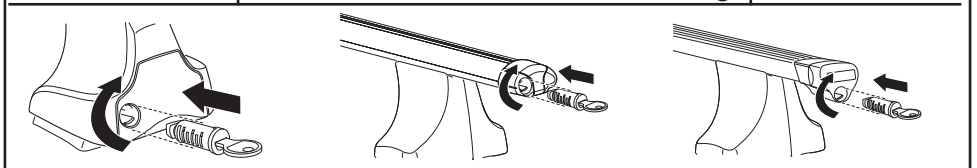

WW ▶ Thule Sweden AB, Box 69, 330 33 Hillerstorp, SWEDEN  
NA ▶ Thule Inc., 42 Silvermine Road, Seymour, Connecticut 06483, USA

info@thule.com  
customer.service@thule.com

www.thule.com