

Kit 1109

NISSAN Mistral, 3-dr SUV, 93-06

NISSAN Mistral, 5-dr SUV, 93-06

NISSAN Terrano II, 3-dr SUV, 93-02, 03-06

NISSAN Terrano II, 5-dr SUV, 93-02, 03-06

FORD Maverick, 3-dr SUV, 93-99

FORD Maverick, 5-dr SUV, 93-99

KIA Sportage, 3-dr SUV, 96-03 / *96-02

KIA Sportage, 5-dr SUV, 94-03, 04-09 / *95-02

*North America

480R
754

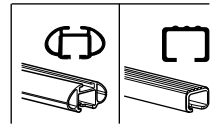
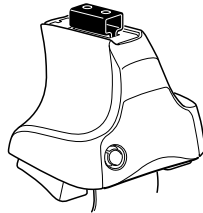

480

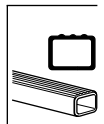
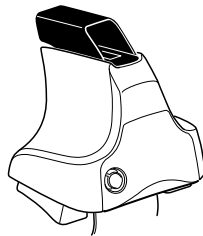

750

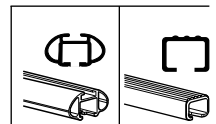
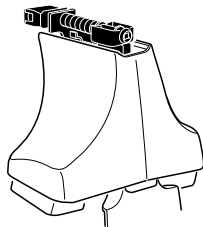

THULE[®]
SWEDEN

ISO 11154-E

Kit

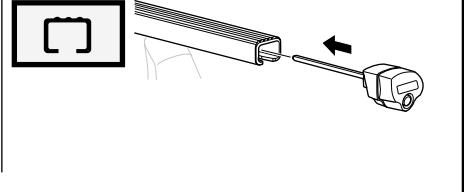
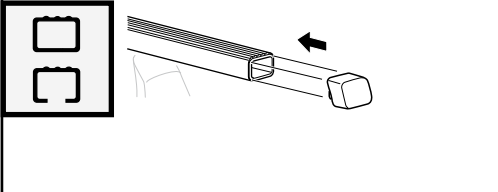
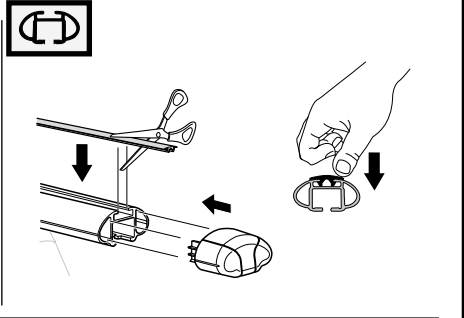
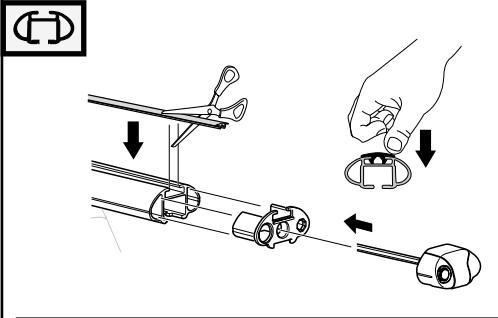
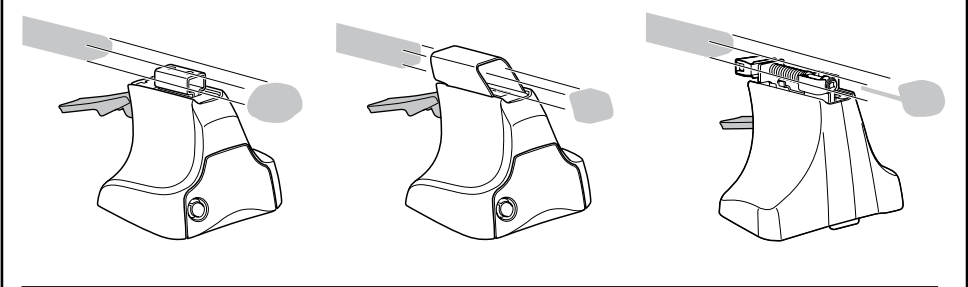
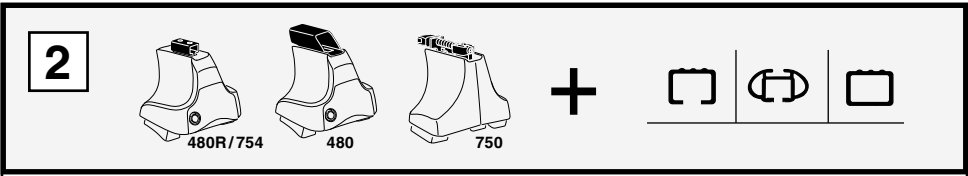
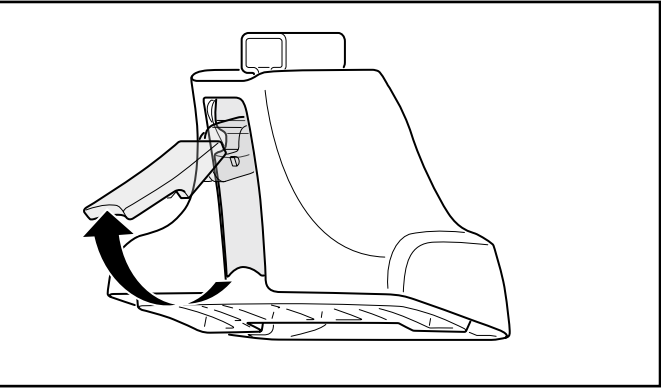
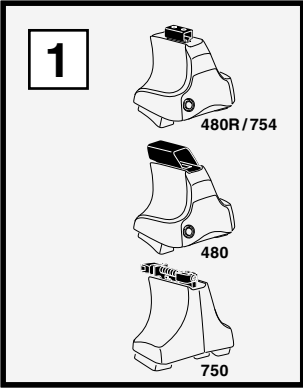

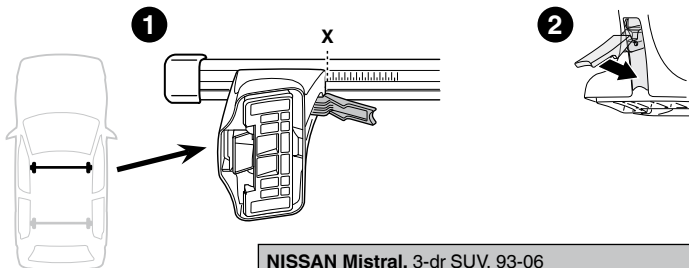
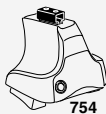
3

	X
NISSAN Mistral , 3-dr SUV, 93-06	33,5
NISSAN Mistral , 5-dr SUV, 93-06	33,5
NISSAN Terrano II , 3-dr SUV, 93-02, 03-06	33,5
NISSAN Terrano II , 5-dr SUV, 93-02, 03-06	33,5
FORD Maverick , 3-dr SUV, 93-99	33,5
FORD Maverick , 5-dr SUV, 93-99	33,5
KIA Sportage , 3-dr SUV, 96-03 / *96-02	31
KIA Sportage , 5-dr SUV, 94-03, 04-09 / *95-02	31

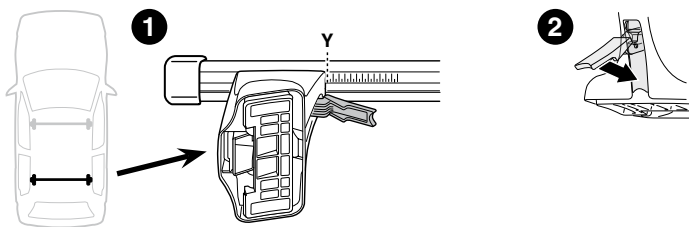

	Y
NISSAN Mistral , 3-dr SUV, 93-06	33,5
NISSAN Mistral , 5-dr SUV, 93-06	32
NISSAN Terrano II , 3-dr SUV, 93-02, 03-06	33,5
NISSAN Terrano II , 5-dr SUV, 93-02, 03-06	32
FORD Maverick , 3-dr SUV, 93-99	33,5
FORD Maverick , 5-dr SUV, 93-99	32
KIA Sportage , 3-dr SUV, 96-03 / *96-02	28,5
KIA Sportage , 5-dr SUV, 94-03, 04-09 / *95-02	28,5

3

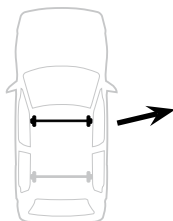
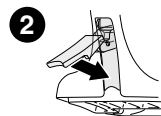
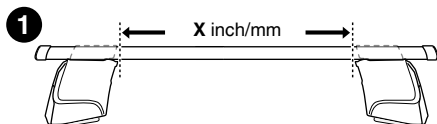

	X inch	X mm
NISSAN Mistral, 3-dr SUV, 93-06	38 $\frac{7}{8}$"	986
NISSAN Mistral, 5-dr SUV, 93-06	38 $\frac{7}{8}$"	986
NISSAN Terrano II, 3-dr SUV, 93-02, 03-06	38 $\frac{7}{8}$"	986
NISSAN Terrano II, 5-dr SUV, 93-02, 03-06	38 $\frac{7}{8}$"	986
FORD Maverick, 3-dr SUV, 93-99	38 $\frac{7}{8}$"	986
FORD Maverick, 5-dr SUV, 93-99	38 $\frac{7}{8}$"	986
KIA Sportage, 3-dr SUV, 96-03 / *96-02	37 $\frac{7}{8}$"	961
KIA Sportage, 5-dr SUV, 94-03, 04-09 / *95-02	37 $\frac{7}{8}$"	961

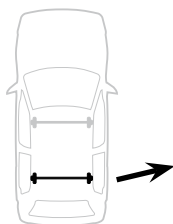
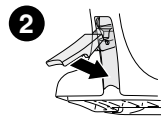
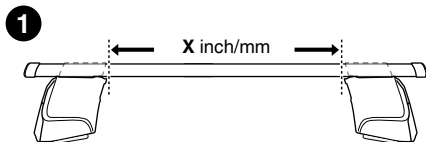

	X inch	X mm
NISSAN Mistral, 3-dr SUV, 93-06	38 $\frac{7}{8}$"	986
NISSAN Mistral, 5-dr SUV, 93-06	38 $\frac{1}{4}$"	971
NISSAN Terrano II, 3-dr SUV, 93-02, 03-06	38 $\frac{7}{8}$"	986
NISSAN Terrano II, 5-dr SUV, 93-02, 03-06	38 $\frac{1}{4}$"	971
FORD Maverick, 3-dr SUV, 93-99	38 $\frac{7}{8}$"	986
FORD Maverick, 5-dr SUV, 93-99	38 $\frac{1}{4}$"	971
KIA Sportage, 3-dr SUV, 96-03 / *96-02	36 $\frac{7}{8}$"	936
KIA Sportage, 5-dr SUV, 94-03, 04-09 / *95-02	36 $\frac{7}{8}$"	936

4

NISSAN Mistral, 3-dr SUV, 93-06
 NISSAN Terrano II, 3-dr SUV, 93-02, 03-06
 FORD Maverick, 3-dr SUV, 93-99
 KIA Sportage, 3-dr SUV, 96-03 / *96-02

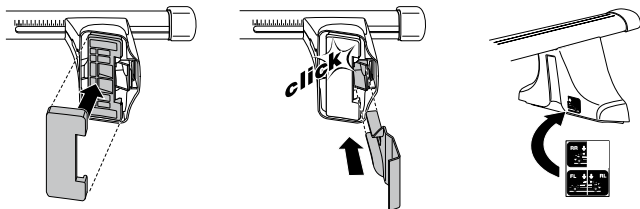
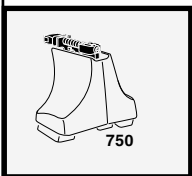
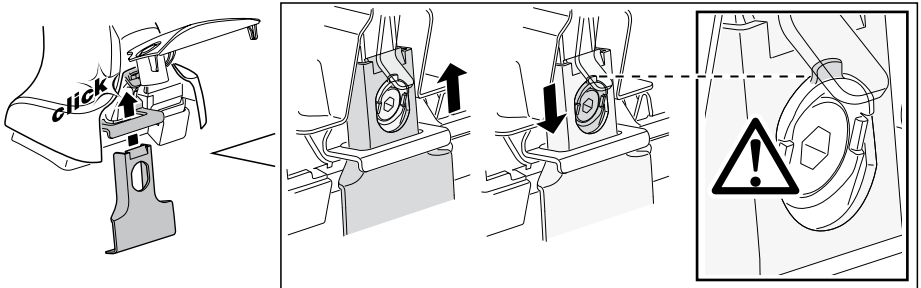
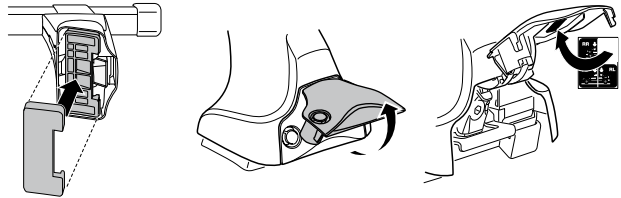
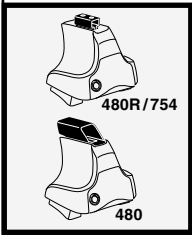
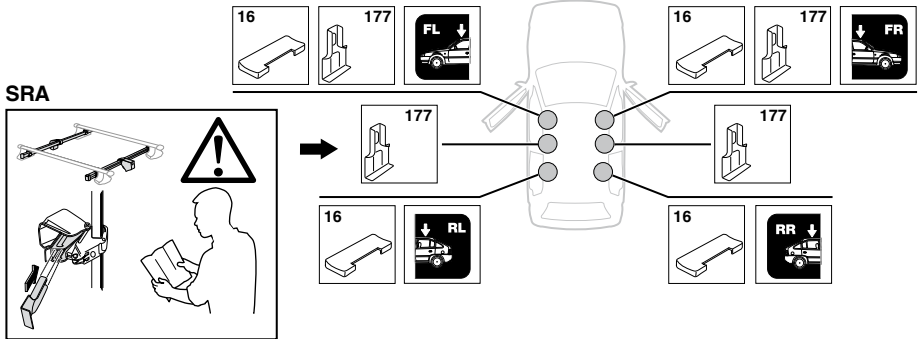

4

NISSAN Mistral, 5-dr SUV, 93-06

NISSAN Terrano II, 5-dr SUV, 93-02, 03-06

FORD Maverick, 5-dr SUV, 93-99

KIA Sportage, 5-dr SUV, 94-03, 04-09 / *95-02

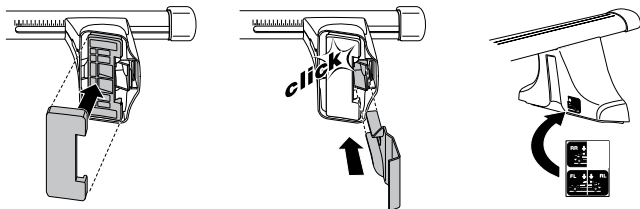
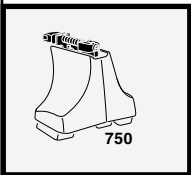
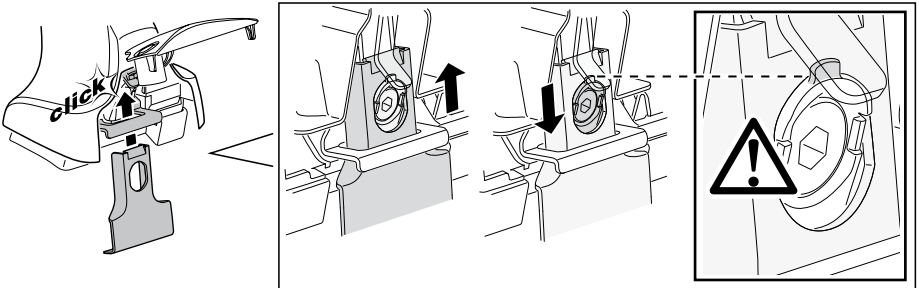
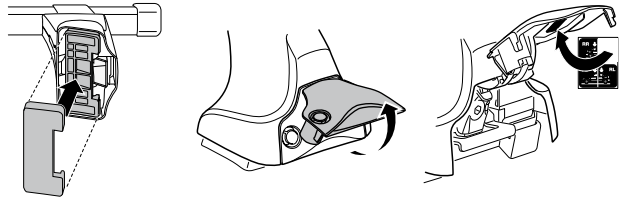
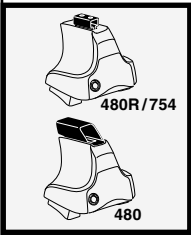
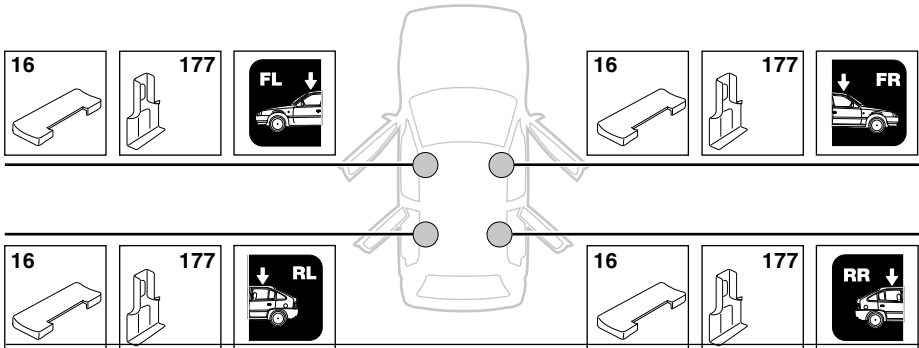

5

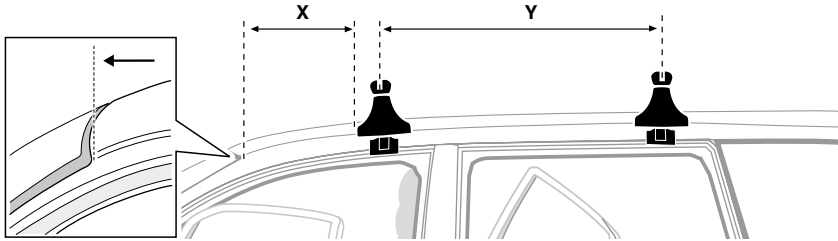
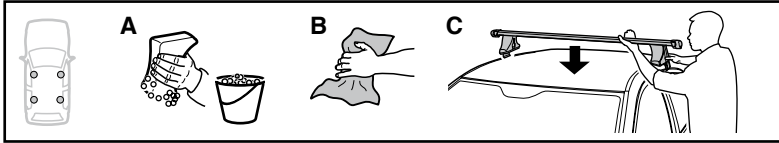

	X mm	Y mm	X inch	Y inch
NISSAN Mistral , 5-dr SUV, 93-06	180 mm	700 mm	7 1/8"	27 1/2"
NISSAN Terrano II , 5-dr SUV, 93-02, 03-06	180 mm	700 mm	7 1/8"	27 1/2"
FORD Maverick , 5-dr SUV, 93-99	180 mm	700 mm	7 1/8"	27 1/2"
KIA Sportage , 5-dr SUV, 94-03, 04-09 / *95-02	270 mm	700 mm	10 5/8"	27 1/2"

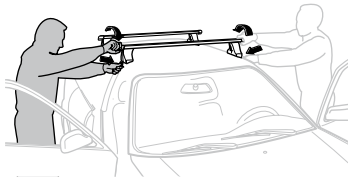
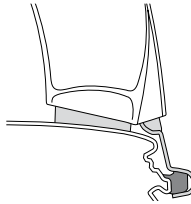

GB/US Tighten alternately

D Die Schrauben abwechselnd anziehen

F Serrer alternativement chaque côté

NL Afwisselend aan de linker- en de rechterkant aandraaien

I Alternare il serraggio delle viti

E Serrare alternativamente

PT Aperte alternadamente

S Dra åt växelvis

- FIN** Kierrä vuorotellen
- EST** Pinguldage vaheldumisi
- LAT** Pielieciet pamišus
- LIT** Užsukinėkite pakaitomis
- PL** Śruby dokręcaj naprzemiennie
- RU** Затягивайте попеременно
- CZ** Pokręťta багаžníka dokręcaj dokręcaj naprzemiennie.
- SK** Doťahujte striedavo
- SLO** Privijajte izmenično.
- HR** Naizmjenično zategnite
- HU** Egymástól függetlenül szorítandó
- GR** Σφίγγετε εναλλάξ
- TR** Dönüşümlü sıkın
- 中文** 交替拧紧
- 한국어** 번갈아 가며 조이십시오.
- 日本語** 交互に締め付けてください。
- ไทย** ขันในแบบสลับ

6

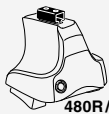

480R/754



480

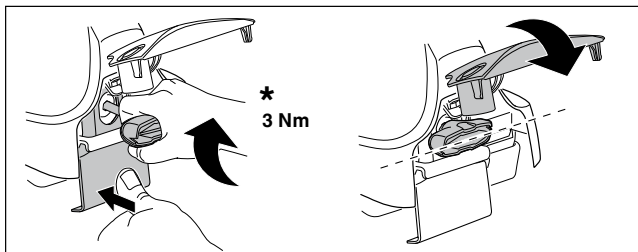
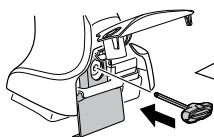

*
3 Nm

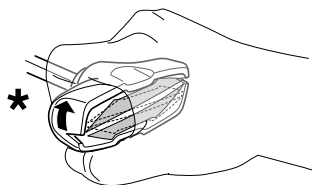

*

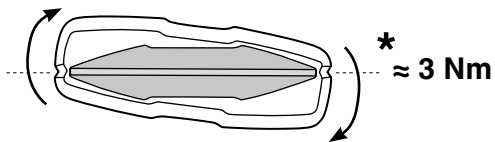

*
≈ 3 Nm

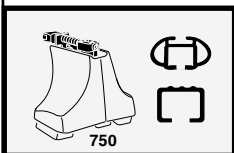
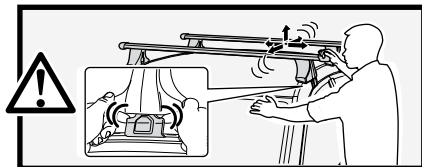

750

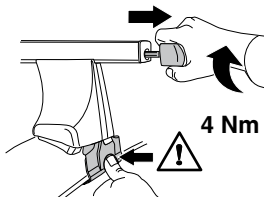

4 Nm

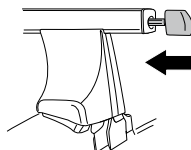

7



x1
17 mm

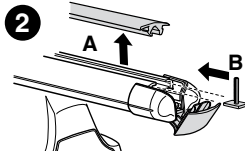
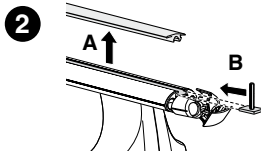
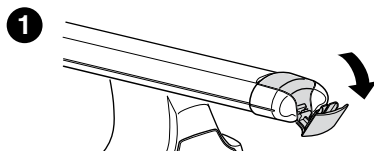
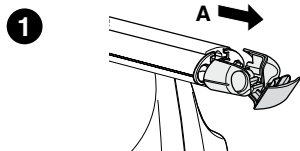
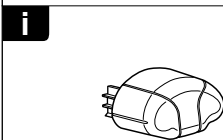
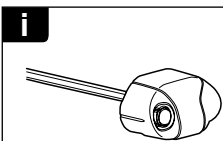
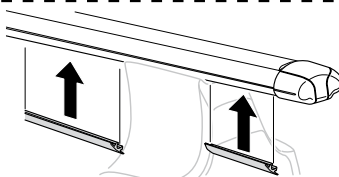

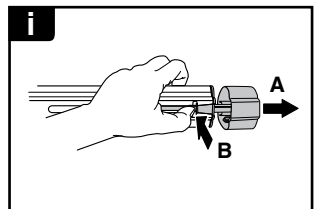
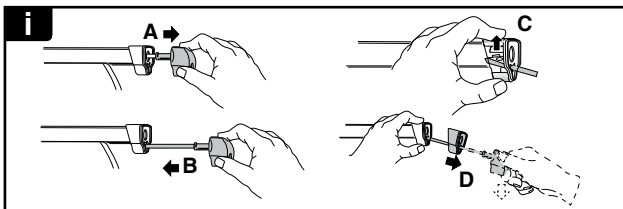
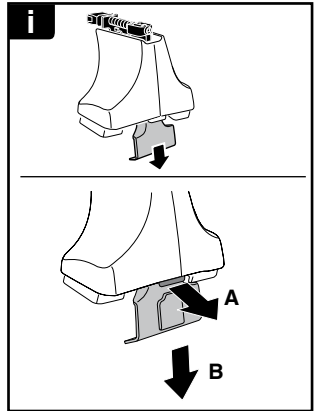
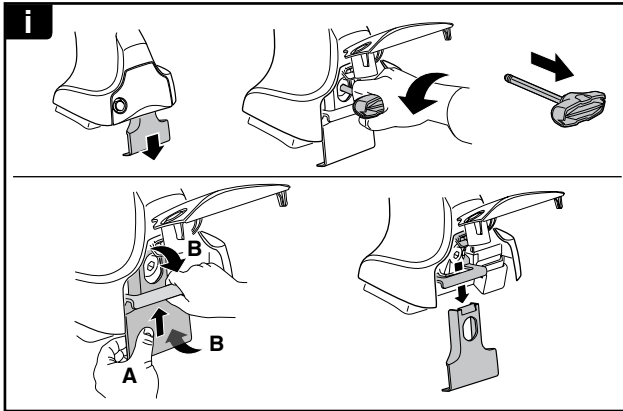
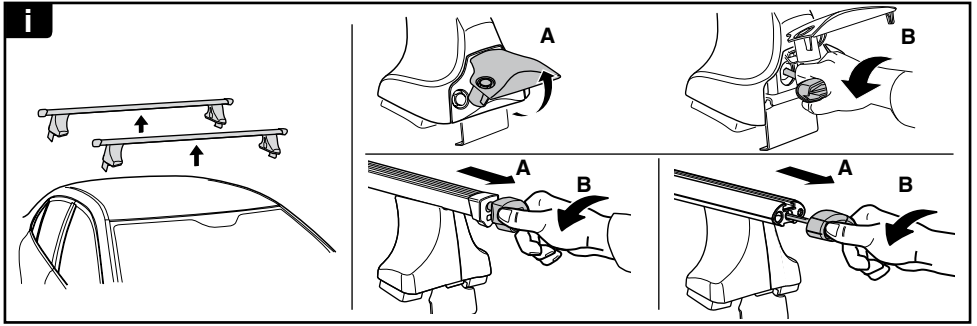

THULE
SWEDEN
**ONE
KEY
SYSTEM**

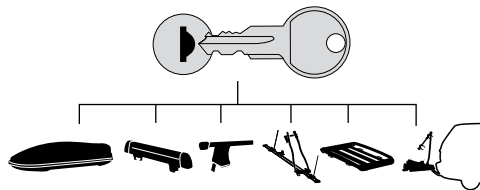

544		(x4)
596		(x6)
588		(x8)
NA 510		(x10)
EUR		
ASIA 452		(x12)

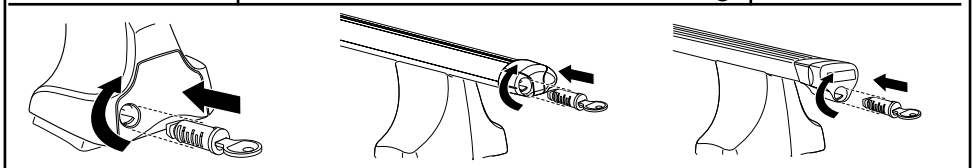

WW ▶ Thule Sweden AB, Box 69, 330 33 Hillerstorp, SWEDEN
NA ▶ Thule Inc., 42 Silvermine Road, Seymour, Connecticut 06483, USA

info@thule.com
customer.service@thule.com

www.thule.com